



COMPLETE DOOR SYSTEMS

**DOORBLOCK**

2.0

by **INDUPANEL**



Casiopea

Fénix

CETUS

Antares

ERIDANO

Carina

Andrómeda

Centauro

Aquila

 **INDUPANEL**  
Doors & Innovation

COMPLETE ODOOR SYSTEMS  
**DOORBLOCK**  
by INDUPANEL

INDUPANEL keeps investing in new designs, research and development, and new technologies to offer the ultimate solutions for such an important feature as like the entrance door of your home.

A front door defines the house personality, a distinctive element full of symbolism, a state of the art.

DOORBLOCK is a high-end product, consequence of our experience and evolution, defining an exclusive and personal choice.

At entrance doors, INDUPANEL goes further.

DRACO

Hércules

Perseo

*DOORBLOCK is a complete door system developed by INDUPANEL, integrating both the panel door (in a wide range of designs, dimensions and finishes), such as frames (one or two sidelights, or upper side may be optionally added), and all kinds of accessories (knobs, lever handles and bar handles, both standard and integrated), security locks, visible or hidden hinges and the latest in home automation systems (opening by fingerprint or mobile application, removing architectural barriers and facilitating access for people with reduced mobility).*

*Everything is fabricated using top quality materials to ensure the safety and durability of the final product, looking for the customer's maximum satisfaction.*

*The high thermal performance of our different cores provides an insulation and energy savings that make this system compliant with Passivhaus standards.*

**AVAILABLE CORES:**

- POLYURETHANE HDP
- PLYWOOD
- PUREN HDP
- ISOLPLUS
- THERMIPANEL EPS/XPS

**FINISHES:**

- RAL POWDER PAINT
- WOODGRAIN

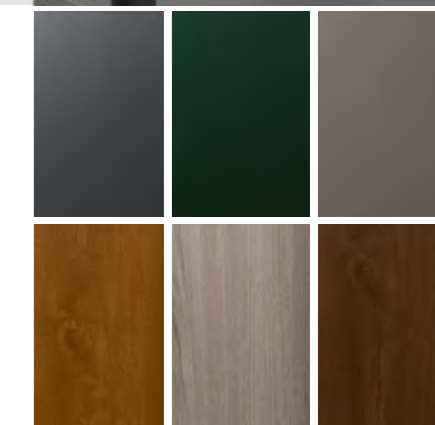

*ÚNICA is INDUPANEL'S most special collection. Inspired by a selection of large constellations whose names come from ancient Greek and Roman mythologies, the ÚNICA model's collection gathers the beauty and uniqueness of the stars and aim to somehow convey an extraordinary story full of strength and splendour.*

*Beyond the myths, fantastic beings, divine fighting's... the objective is achieving a different perception of the front door, seeking a conceptual transcendence.*

*With sets of reliefs, metal-imitating resins, and ad hoc pull handles, these models combine innovation, aesthetics and their own personality.*

*EVERY TEXTURED DOOR IN THE UNIQUE COLLECTION IS MADE IN A ARTISANAL WAY AND PRESENTS A HANDMADE FINISH. SO NO TWO ARE EXACTLY THE SAME. RESULTING IN A UNIQUE AND EXCLUSIVE PIECE.*

*Enter a new galaxy of front doors.*



FÉNIX



HÉRCULES

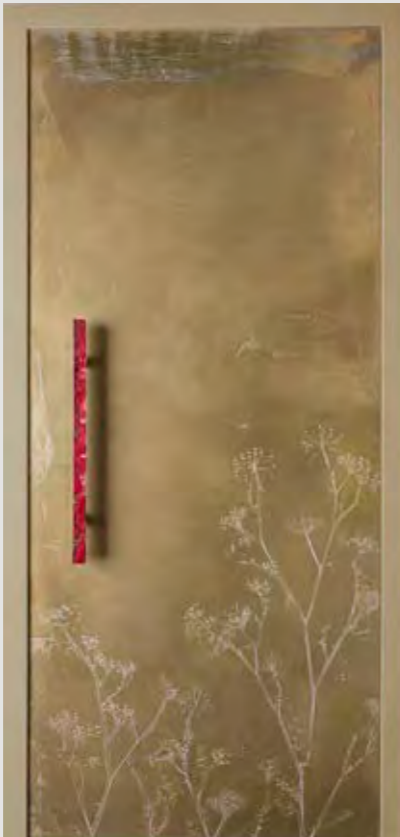

CENTAURO



ALYA

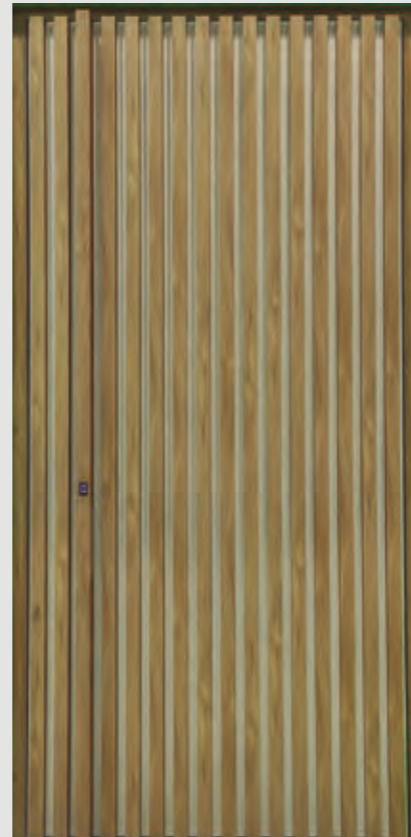

ATRIA



DRACO

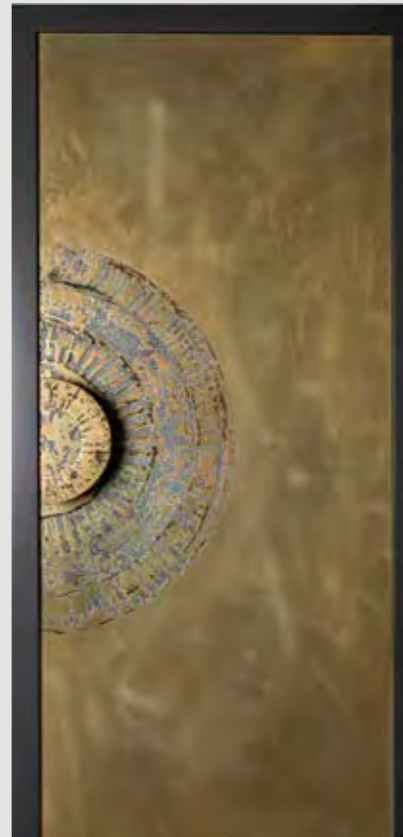

ANDRÓMEDA



CASIOPEA



CETUS



ANTARES



ERÍDANO



CRUX

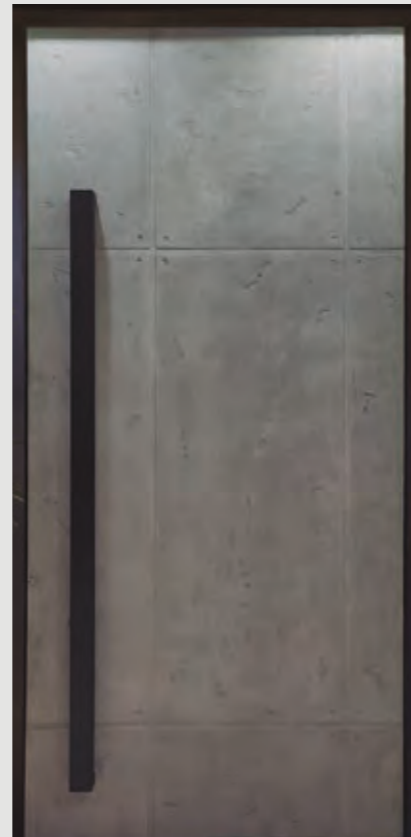

FORNAX GLACIAR

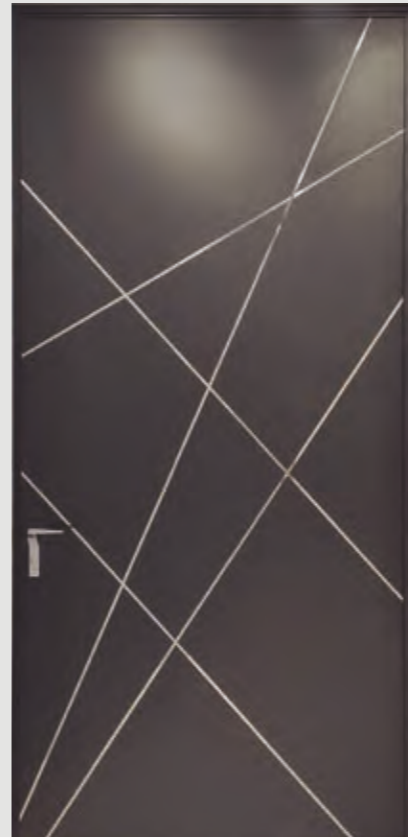

PERSEO



AQUILA



CARINA





**Novelty release!**

**DOORBLOCK**  
by **INDUPANEL** **PIVOT DOOR**  
**SYSTEM**

**PIVOT DOOR**  
**4 LINE**  
Colour: Golden oak  
Details: 88 mm thickness profile



**PIVOT DOOR**  
**ANTARES**  
Colour: Textured bronze  
Accessory: AM-22 Customized  
Details: 88 mm thickness profile



KRETA

**INDUPANEL** incorporates the latest design trends for industrial or minimalist styles, by using **DEKTON**, a surface with high resistance to UV rays and high temperatures, ice, abrasion, stains and scratches.

A wide variety of surprising colors and textures, which allow you to achieve great versatility for your project, unleashing creativity and adapting to the space you inhabit. A range of finishes with which you will achieve an incomparable aesthetic and a surprising result.



ARGA



AURA15

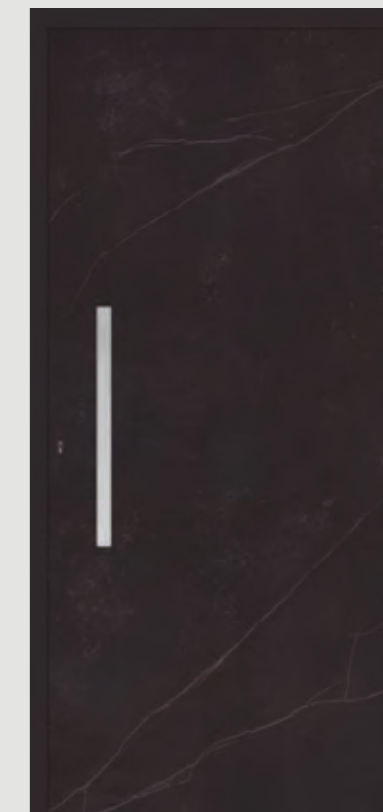

KELYA

**Novelty  
release!**

**DEKTON®**  
**COSENTINO®**



LAURENT



LAOS

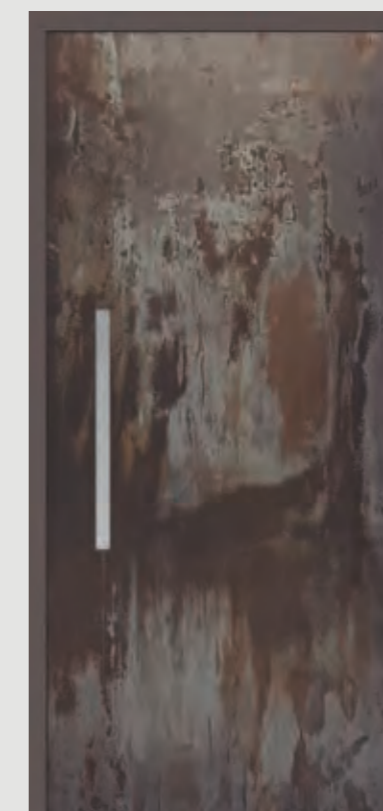

TRILIUM

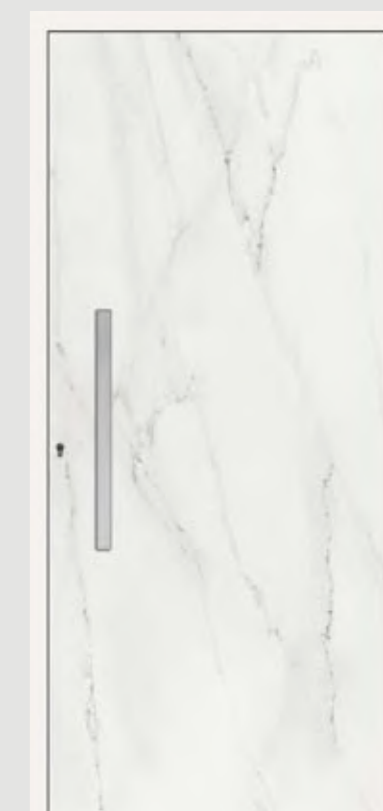

REM



**FLAT PANEL**  
Colour: Dekton Laos  
Accessory: Customized

**DOORBLOCK**  
by **INDUPANEL**



**ANDRÓMEDA**  
Colour: Foil 1660857 Sahara Cement  
Accessory: Concealed handle  
Details: Resin piece  
LED lighting

**ÚNICA**



**CASIOPEA**  
Colour: Foil 1540925  
Sahara Oxide  
Accessory: Guadiana  
Details: Curved surface

Majestic design, with the pull **handle** as the undisputed protagonist, acting like a connecting element between the two panel levels: the flat part of the panel and the curved part, which bends allowing a perfect handgrip on its opening.

Design and ergonomics for a astounding result.







## ERÍDANO

Colour: Foil 20057004 Desert Oak  
and anthracite grey resin  
Details: Stainless steel straps

With the contrast as  
a purpose, this piece  
with organic shapes  
inspired by the nature,  
is added to create  
a three-dimensional  
experience and unique  
sensations to the touch.



**CENTAURO**  
Colour: Aged concrete  
Accessory: ÚNICA 6

Resin decorated door,  
with a smooth texture  
and finished in aged  
concrete creating  
amazing shades.

The textured handle  
with python skin  
rounds up the  
set with harmony.





**AQUILA**  
Colour: Oxide resin  
Accessory: UNICA 10  
Details: Three-dimensional surface



Set consisting of overlapping pieces of different sizes and depths, with rough texture and oxide imitation finish, resulting in a powerful and eye-catching visual style





**IGUAZÚ**

Colour: Mountain Oak foil  
Glass type: Coloured diamond  
Accessory: UNICA 7  
Details: Double direction grain



Unique set where the **grain** is arranged in two different directions according to the sections: horizontal or vertical.

Seven individual pieces treated with care and giving a highly appearance of a true wooden door.





## INNOVATION

Opening system with a **concealed handle**.

longitudinally drawn (parallel to the edge of the panel), with an ergonomic opening for a comfortable inner hand grip, giving a clean surface to the door appearance and avoiding any overlapping elements.

This system also allows the incorporation of a LED lighting, a flexible strap that perfectly fits inside the handle and gives a dim light, providing a brilliant result to the door overall assembly.

The size and position of this handle is totally customizable and adaptable to the design of each door, either in the same panel finish or a different one to get a contrast.



### 4 LINE

Colour: RAL\_7016  
Accessory: Concealed handle  
Details: Bluetooth opening



**ANTARES**

Made of resin, with a smooth textured part and another rough textured with a spatula effect. Finished in bronze and handle covered with python leather texture



ÚNICA 1



Handle 252



**PERSEO**

With a centre handle in glass, design from which grows a surrounding linear grooving



ÚNICA 2

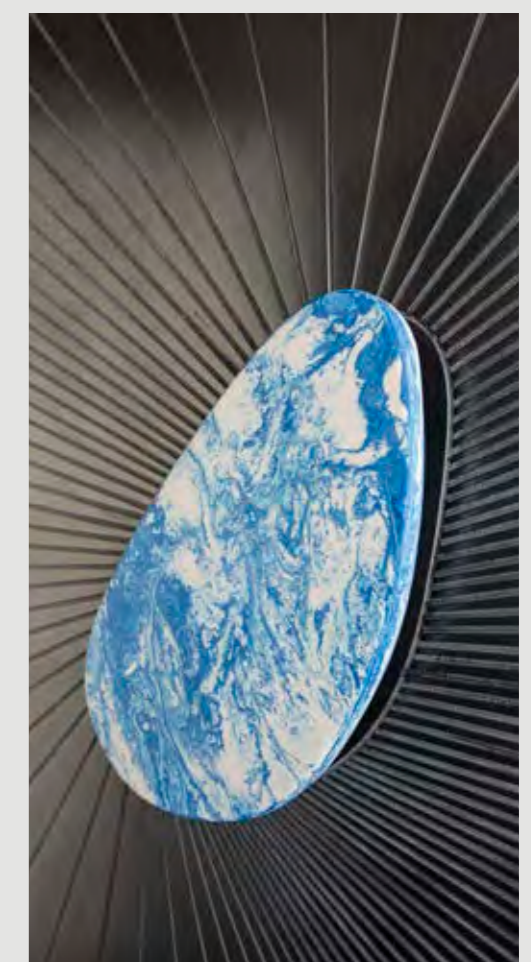

ÚNICA 3



ÚNICA 4

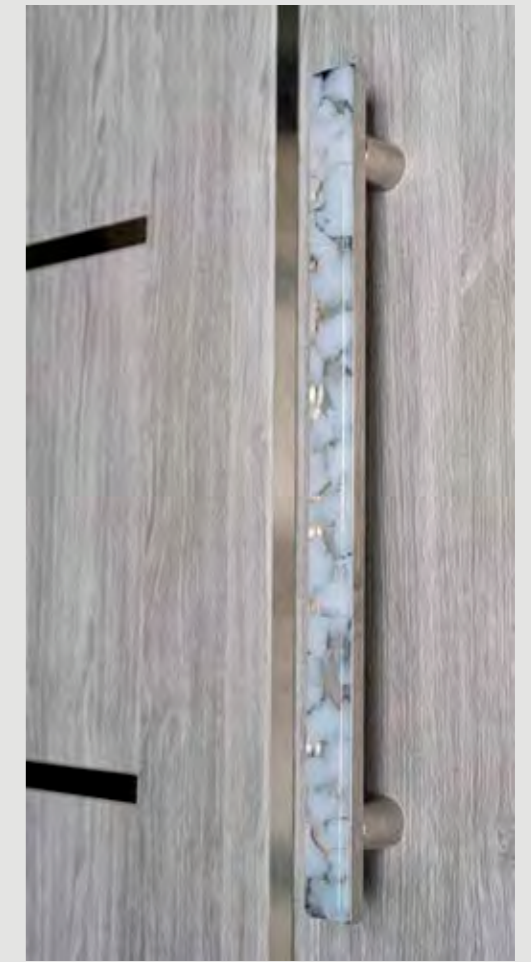

ÚNICA 5



MA 7



NAT 7

**CETUS**

Resin door with three-dimensional shapes providing a sensation of depth and movement. Aged copper finished.



**DRACO**

Unique design made of resin, rough textured in a geometric design with the handle and aged gold finished



**FÉNIX**

Three-dimensional artwork captured on a door, creating an exclusive result, finished in silver

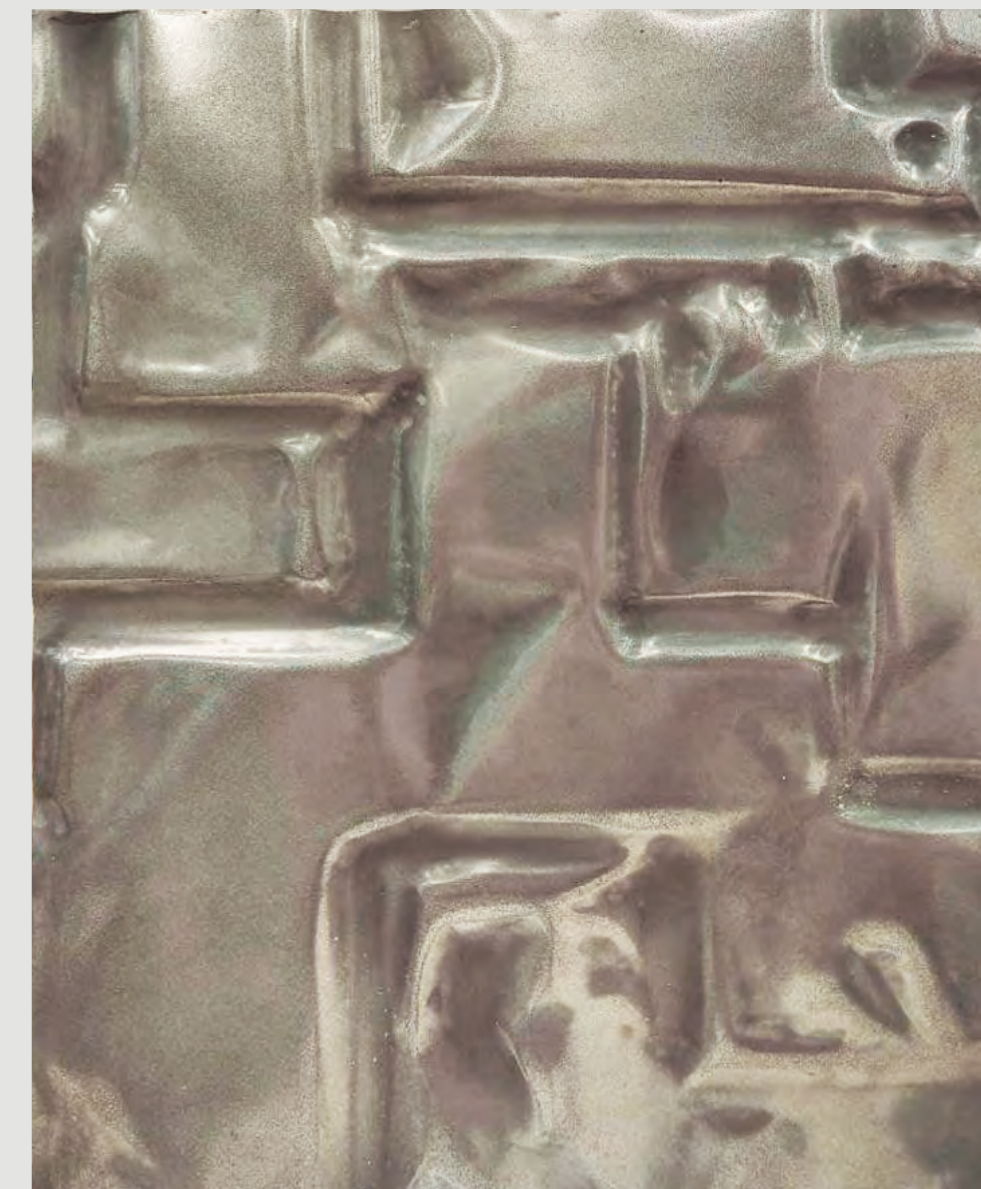





**New!** ATRIA  
Colour: Foil 4703004  
Accessory: Concealed handle



DOORBLOCK  
by INDUPANEL



**New!** CRUX  
Colour: Concrete resin  
Accessory: Customized



**New!**

FORNAX  
Colour: RAL\_7021  
Accessory: MA II  
Details: Grooves

**DOORBLOCK**  
by **INDUPANEL**



**New!**

FORNAX GLACIAR  
Colour: RAL\_9011  
Details: Stainless steel

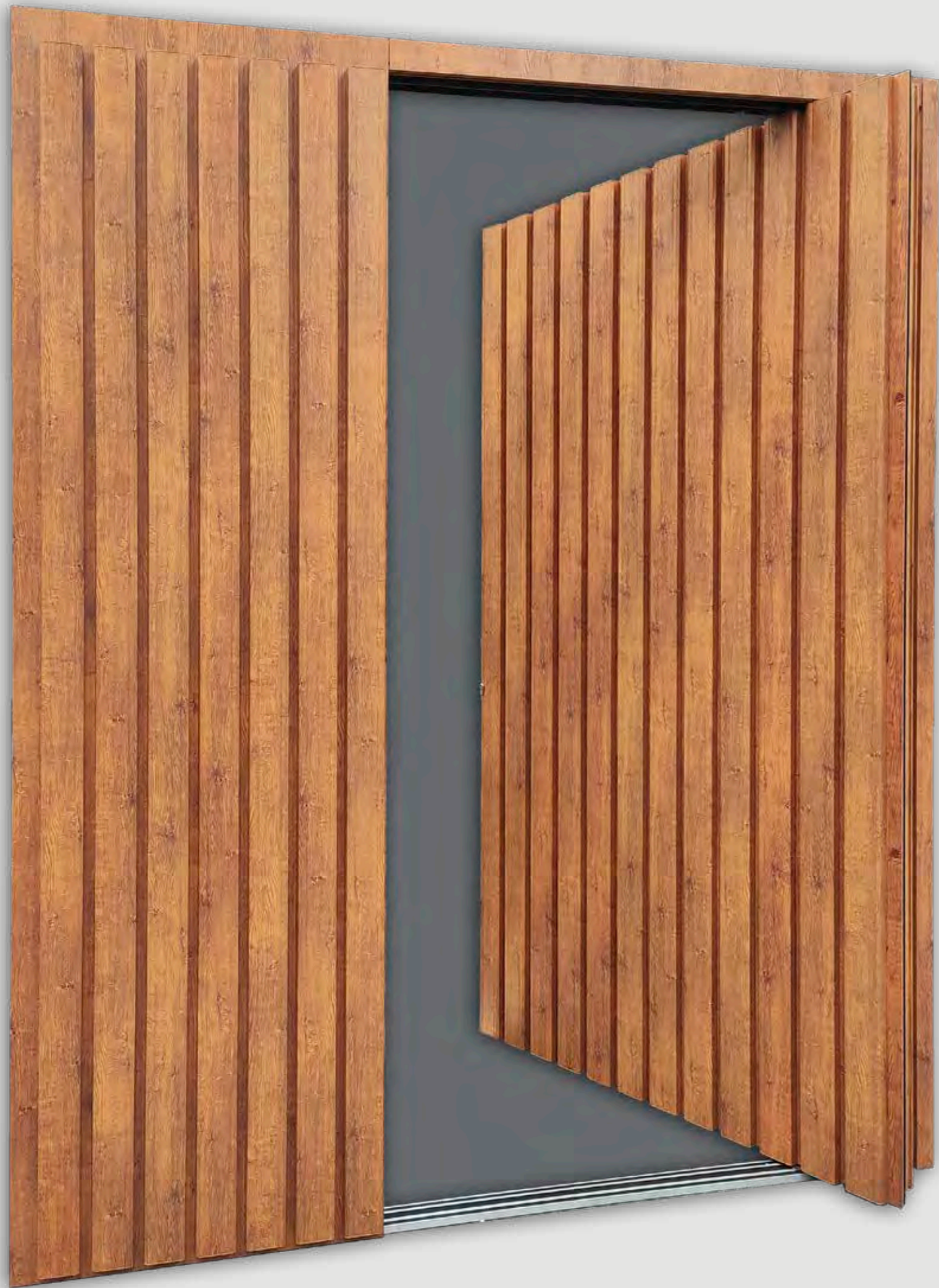

**New!** PIVOT DOOR  
ALYA  
Colour: Golden oak  
Details: Overlapped stripes

DOORBLOCK  
by INDUPANEL



**New!** ALYA  
Colour: Foil 4703001 and RAL\_9010  
Accessory: Concealed handle  
Details: Overlapped stripes  
Fingerprint scanner



**AVANT COLLECTION**

Vanguard and versatility through unique steels, geometries and glasses

**NAVIA**

Colour: RAL\_9016  
 Glass type: Coloured diamond  
 Accessory: 254  
 Details: Stainless steel sheet



**SENEGAL**

Colour: RAL\_9016  
 Glass: Coloured diamond  
 Accessory: 124  
 Details: Grooves



**PARANÁ**

Colour: RAL\_7024  
 Glass type: Reflective  
 Accessory: 252  
 Details: Stainless steel and grooves



**New!**

NÍGER  
Colour: RAL\_7021  
Glass type: Matt  
Accessory: 135  
Details: Stainless steel

**DOORBLOCK**  
by **INDUPANEL**



**New!**

CONGO GLACIAR LIDO  
Colour: RAL\_7012  
Glass type: Mate  
Accessory: 142  
Details: Stainless steel and grooves



**AVPLUS COLLECTION**

Minimalist and contemporary designs  
fruit of an innovative impulse

**AVPLUS 13**

Colour: RAL\_7021  
Glass type: Diamond matt  
Accessory: 142  
Details: Stainless steel



**AVPLUS 3**

Colour: RAL\_7021  
Glass: Coloured diamond  
Accessory: 125  
Details: Stainless steel



**AVPLUS 14**

Colour: RAL\_9016  
Glass type: Colour stained  
Accessory: 250  
Details: Stainless steel



**+LIDO COLLECTION**

Geometric sets through linear grooves that will surprise you

**L26**

Colour: RAL\_7021  
Glass type: Solid  
Accessory: 140  
Details: Grooves



**L18**

Colour: RAL\_7021  
Glass type: Solid  
Accessory: 123  
Details: Grooves



**L21**

Colour: RAL\_9001  
Glass type: Solid  
Accessory: 142  
Details: Grooves



**INNOVA COLLECTION**

Exclusivity and innovation, with the accessory as protagonist designed "ad-hoc"

**STYLE 7**

Colour: RAL\_7021  
Glass type: Matt  
Accessory: IN-8  
Details: Grooves



**STYLE 1**

Colour: RAL\_7021  
Glass type: Matt  
Accessory: IN-1  
Details: Grooves

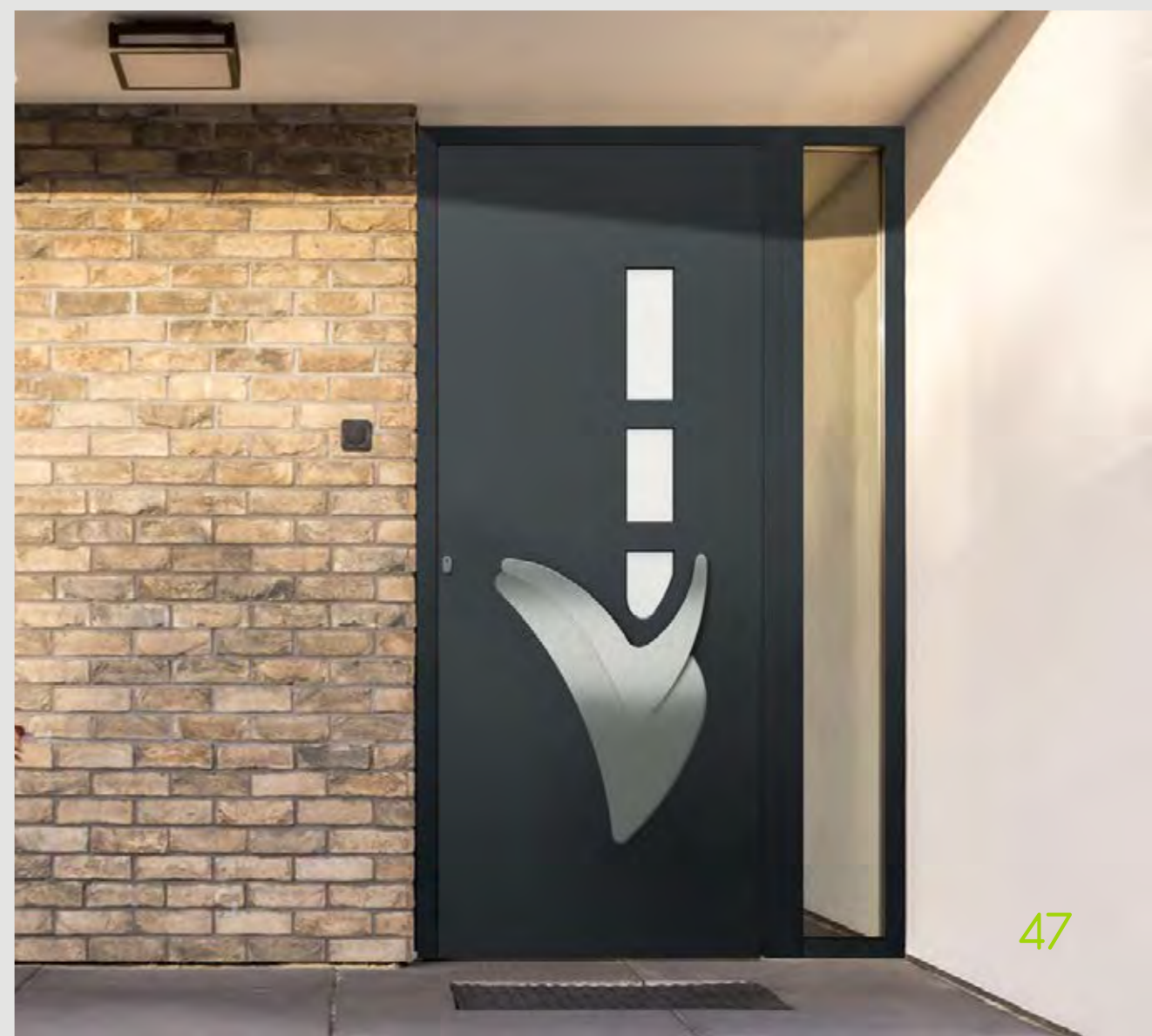

**PLUS 2**

Colour: RAL\_7016  
Glass type: Matt  
Accessory: IN-4  
Details: Stainless steel sheet





**LINE COLLECTION**

Our series of doors with grooved lines and incomparable aesthetic

**4 LINE**

Colour: RAL\_7016  
 Glass type: Solid  
 Accessory: MA 5  
 Details: Customizable number of grooves



**8 LINE**

Colour: Folio Mountain Oak  
 Accessory: 142  
 Details: Customizable number of grooves



**FLAT PANEL**

Colour: RAL\_7016  
 Accessory: Concealed handle

**DOORBLOCK**  
 by **INDUPANEL**



RED

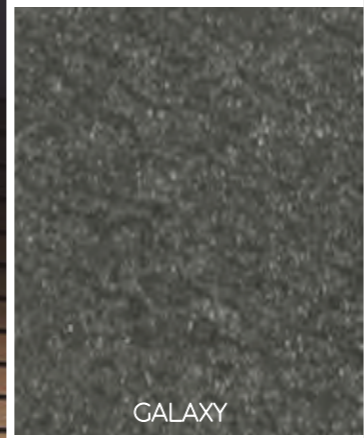

GALAXY

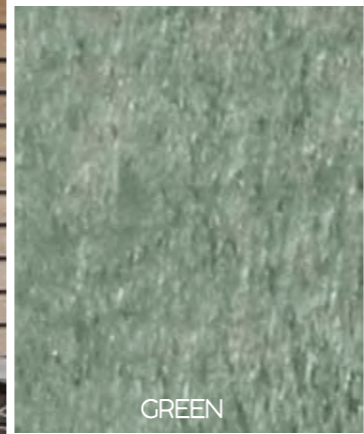

GREEN

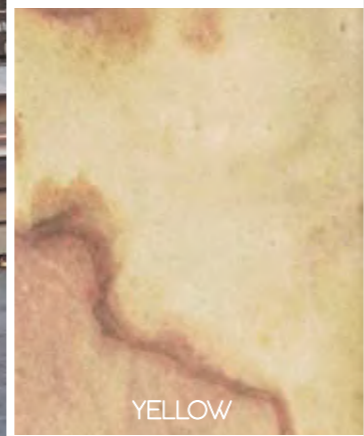

YELLOW



GREY



**NATURA 11**  
 Colour: RAL\_7009  
 Accessory: Nat 11  
 Details: Red natural stone  
 and stainless steel

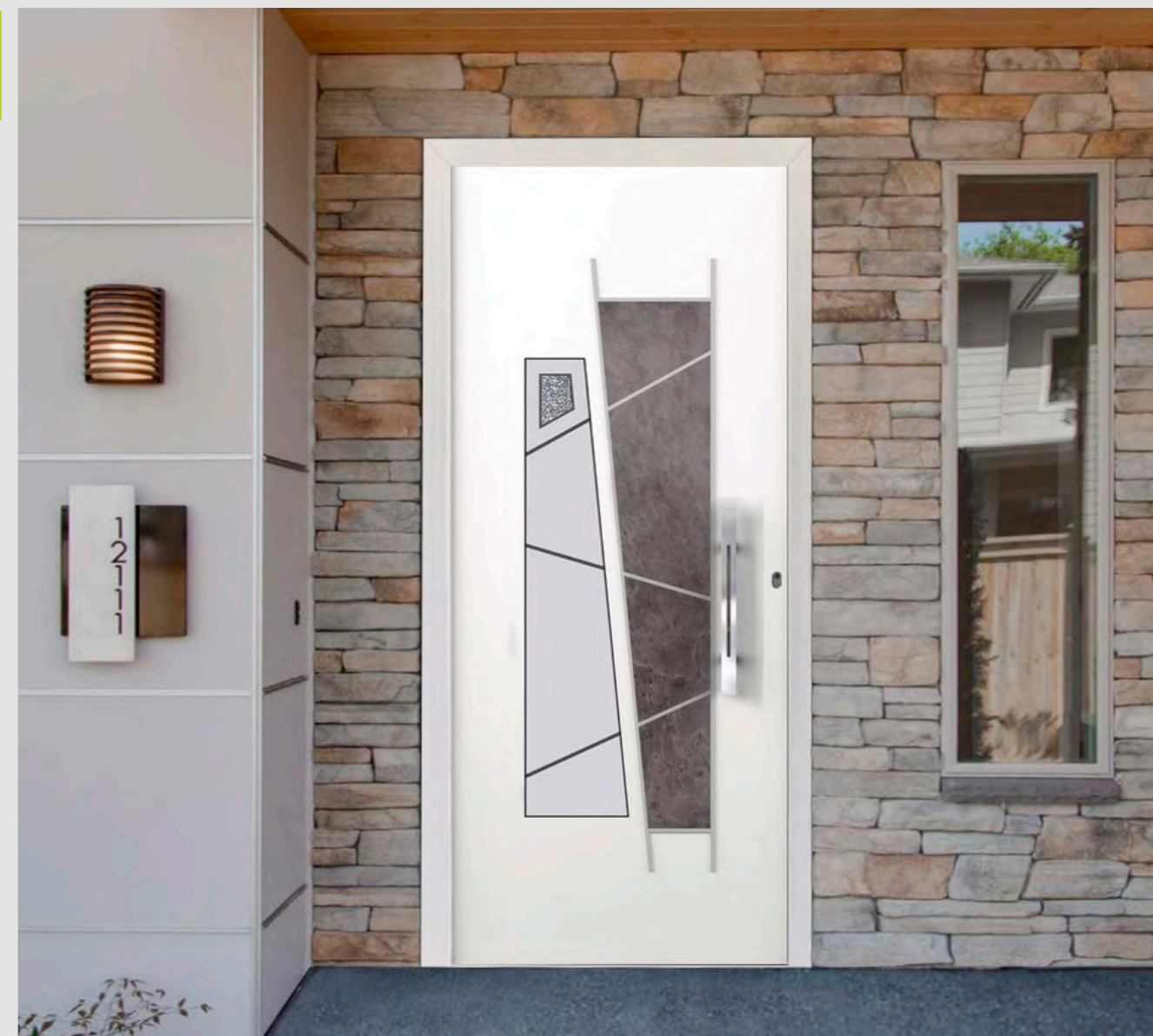

**NATURA 6**  
 Colour: RAL\_9016  
 Glass type: Diamond matt  
 Accessory: Nat 6  
 Details: Grey natural stone  
 and stainless steel

## NATURA COLLECTION

Its main feature is the integration of natural elements, such as stone, which gives it a durable and original look.

### NATURA 1

Colour: Golden Oak  
 Glass type: Diamond matt  
 Accessory: Nat 1  
 Details: Grey natural stone  
 and stainless steel



## PIVOT DOOR SYSTEM PIVOT90

PIVOT DOOR SYSTEM, BONDED ON BOTH SIDES

All pivot doors come with the following basic features:

- 88 mm thickness profile
- 88 mm thickness panel
- 2 mm THICKNESS ALUMINIUM SHEET
- FLUSH PANEL WITH FRAMES BOTH SIDES
- 3 POINTS LOCK
- Glass thickness for sidelights: 32 mm (Consult other values)
- Core EPS ( $d=30 \text{ kg/m}^3$ )
- Maximum door height: 3.000 mm
- Maximum door width: 2.000 mm
- Aluminium frame and panel in powder paint finish
- Solid panel or panel with triple laminated glass and double chamber for better insulation
- Thermal seal with shear-free insulating profile (page 59)
- Safety cylinder
- Low threshold in between the side frames
- EPDM joints
- Fin-Seal brush
- Lever handle
- Air permeability: CLASS 3
- Watertightness: CLASS 1A
- Wind resistance: CLASS C3

Optional extras:

- Motorised lock, with different types of electronic openings available: fingerprint, bluetooth, code, card... (page 63)
- Handle: concealed (page 24), from catalogue (page 67), customized...
- Hidden door closer (page 79)
- Motorised opening (page 81)
- High safety cylinder (page 79)
- Electronic or digital wireless spyhole (page 65)
- Concealed threshold
- Sidelight: glazed, paneled, bonded...

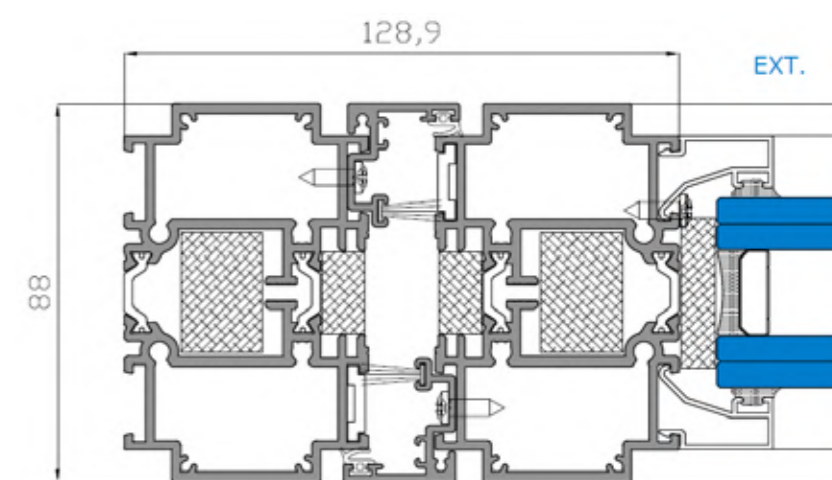

PANELED SIDE



BONDED SIDE PANEL

**Novelty release!**

PIVOT DOOR  
5 LINE  
Colour: RAL\_9005  
Details: 88 mm thickness profile

## PIVOT DOOR SYSTEM PIVOT80

PIVOT DOOR SYSTEM, BONDED ON BOTH SIDES

All pivot doors come with the following basic features:

- 80 mm thickness profile
- 80 mm thickness panel
- 25 mm THICKNESS ALUMINIUM SHEET
- FLUSH PANEL WITH FRAMES BOTH SIDES
- 3 POINTS LOCK
- Glass thickness for sidelights: 32 mm (Consult other values)
- Core EPS ( $d=30 \text{ kg/m}^3$ )
- Maximum door height: 3.000 mm
- Maximum door width: 2.100 mm
- Aluminium frame and panel in powder paint finish
- Thermal seal with shear-free insulating profile (page 59)
- Safety cylinder
- Low threshold in between the side frames
- EPDM joints
- Lever handle
- Air permeability: CLASS 4
- Watertightness: CLASS 5A
- Wind resistance: CLASS C5

Optional extras:

- Motorised lock, with different types of electronic openings available: fingerprint, bluetooth, code, card... (page 63)
- Handle: concealed (page 24), from catalogue (page 67), customized...
- Hidden door closer (page 79)
- Motorised opening (page 81)
- High safety cylinder (page 79)
- Electronic or digital wireless spyhole (page 65)
- Sidelight: glazed, paneled, bonded... (page 53)

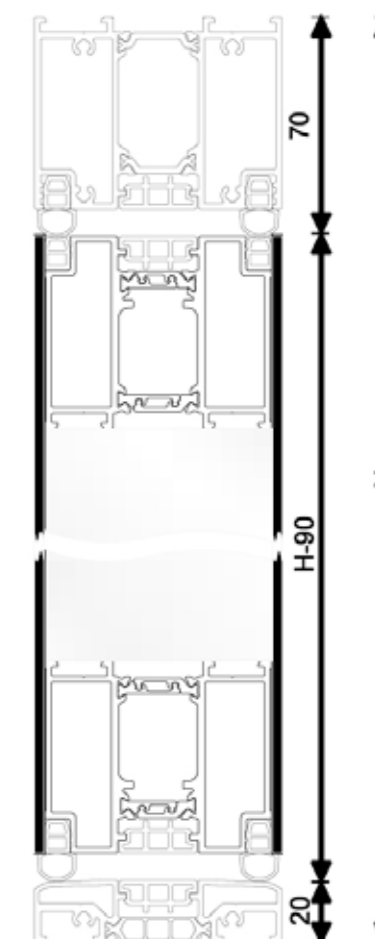
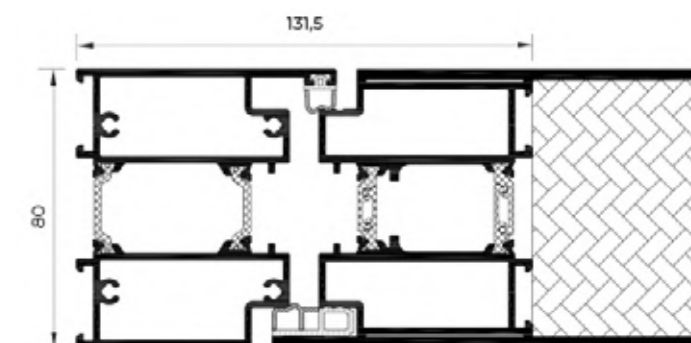

**Novelty release!** PIVOT DOOR  
NATURA 5  
Colour: RAL Oxide  
Details: Natural stone

## DOORBLOCK SYSTEM

### COMPLETE BONDED DOOR SYSTEM ON BOTH SIDES

All DOORBLOCK doors come with the following basic features:

- 70 / 80 mm thickness profile
- 70 / 80 mm thickness panel
- 25 mm THICKNESS ALUMINIUM SHEET
- FLUSH PANEL WITH FRAMES BOTH SIDES
- 3 POINTS LOCK
- VISIBLE HINGES (at least 3, powder painted in the color of your choice, except woodgrain)
- Glass thickness for sidelights: 24 mm and 40 mm (Consult other values)
- Core EPS ( $d=30 \text{ kg/m}^3$ )
- Maximum door height: 3.000 mm with visible hinges  
2.700 mm with hidden hinges
- Maximum door width: 1.800 mm with visible hinges  
1.500 mm with hidden hinges
- Aluminium frame and panel in powder paint finish
- Solid panel or panel with triple laminated glass and double chamber for better insulation
- Thermal seal with shear-free insulating profile (page 59)
- Safety cylinder
- Low threshold in between the side frames
- Lever handle
- Air permeability: CLASS 2
- Watertightness: CLASS 2A
- Wind resistance: CLASS C4
- Impact resistance: CLASS 5 (SOLID)
- Maximum acoustic insulation:  $R_w=28$  (-4; -4) dB (SOLID)  
 $R_w=30$  (-2; -2) dB (GLASS)
- Thermal transmittance:  $U_w=11 \text{ W/m}^2\text{K}$  (SOLID)  
 $U_w=16 \text{ W/m}^2\text{K}$  (GLASS)

### Optional extras:

- Motorized lock, with different types of electronic opening available: fingerprint, bluetooth, code, card... (page 63)
- Handle: concealed (page 24), from catalogue (page 67), customized...
- Hidden hinges (at least 3) (page 78)
- Hidden anti-lever system (page 79)
- Hidden door closer (page 79)
- Motorised opening (page 81)
- High safety cylinder (page 79)
- Electronic or digital wireless spyhole (page 65)
- Double door
- Sidelight: glazed, paneled, bonded... (page 53)

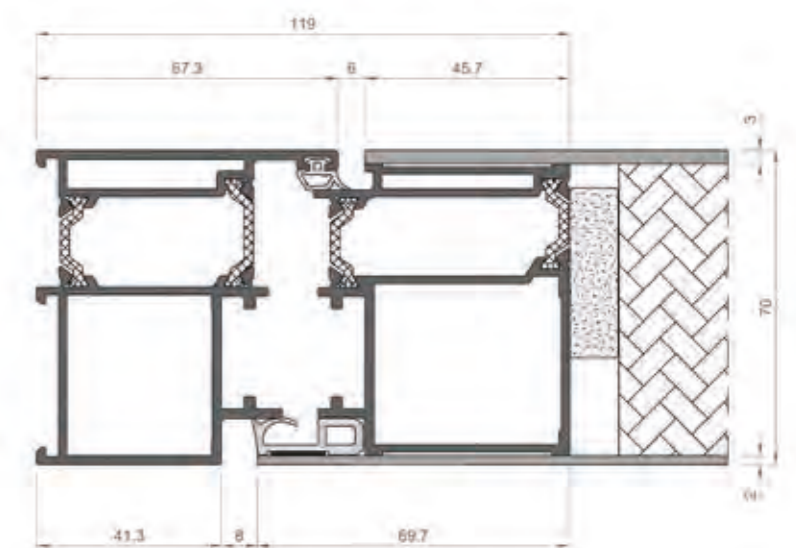

DOOR THRESHOLD:

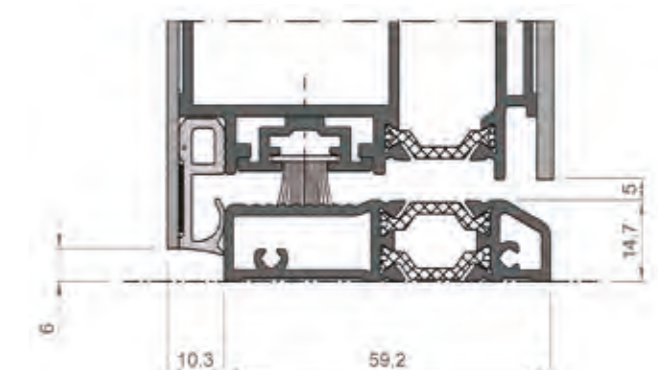

AVPLUS 9  
Colour: RAL 9005  
Glass type: Mat  
Accessory: 139  
Details: Stainless steel



AVPLUS 1  
Colour: RAL 7021  
Glass type: Diamond matt  
Accessory: 135

## SHEAR-FREE INSULATING PROFILE

Minimizes the longitudinal expansion produced by the outside-inside temperature difference

This polyamide keeps the door in perfect shape even when there are extreme differences between the external and internal temperature. It consists of two intermeshing parts which, with temperature-related, differing linear expansion of the inner and outer shells, the two parts move against one another.

This generates a moveable, corrective insulating zone which minimises the bi-temperature effect and reduces deformation effectively.

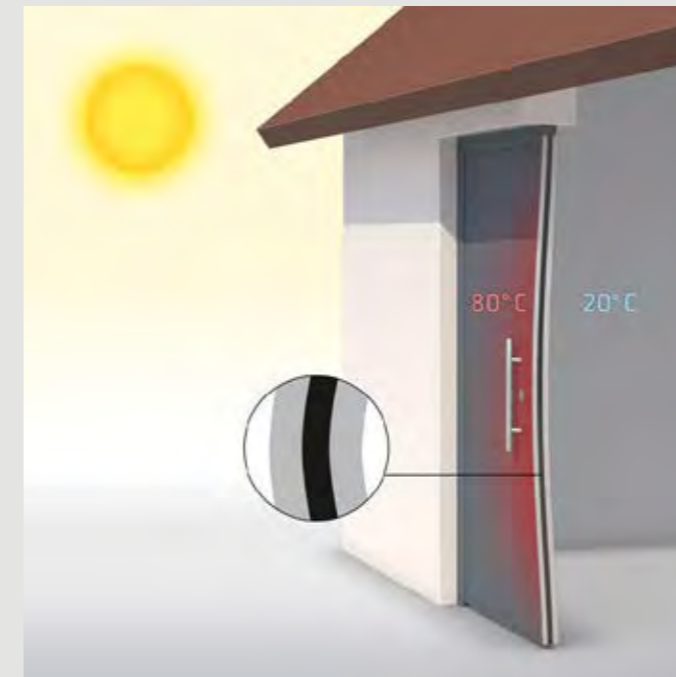

In an aluminium assembly with a conventional insulating profile, the large temperature difference causes the door to become deformed.

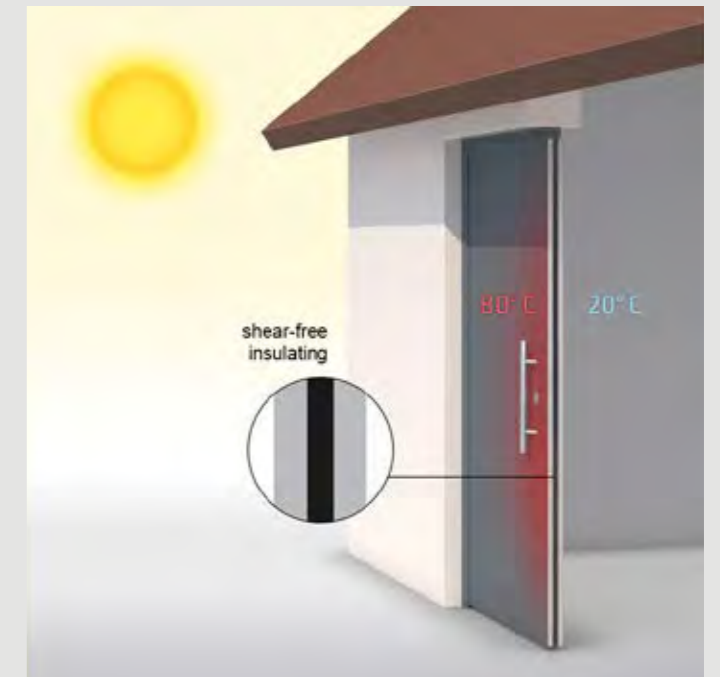

When the shear-free insulating profile is used, the differing linear expansion values of the inner and outer shells are evened out effectively.

### BENEFITS:

- No shear: minimization of the bi-temperature effect compared to flexible and rigid profiles to shear
- Minimum elastic shear stiffness  $c$  and low shear strength  $T$
- Optimized geometry for high transverse tensile strength  $Q$
- Can be assembled and coated as a traditional insulating profile

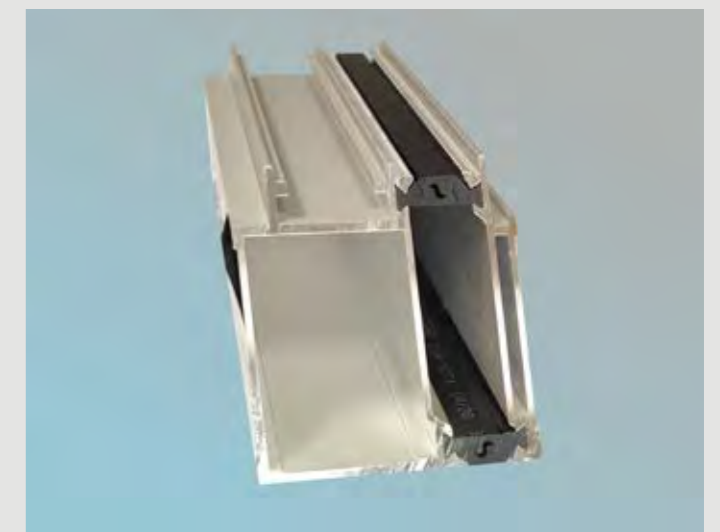



**SELLA**  
 Colour: RAL\_7021  
 Glass type: Matt  
 Accessory: 142

- ① ALUMINIUM PANEL, 70 OR 80 mm THICKNESS FRAMES, BONDED ON BOTH SIDES, WITH 2'5 mm THICKNESS SHEET
- ② ALUMINIUM FRAME WITH THERMAL SEAL AND SHEAR-FREE INSULATING PROFILE
- ③ CONCEALED HANDLE AND INTERIOR/ EXTERIOR ACCESSORIES (LEVER HANDLES AND BAR HANDLES)
- ④ MULTIPOINT SECURITY LOCK
- ⑤ AUTOMATIC OPENING SYSTEMS (FINGERPRINT, BLUETOOTH...)
- ⑥ DOOR LOW THRESHOLD
- ⑦ TRIPLE LAMINATED GLASS AND DOUBLE CHAMBER
- ⑧ VISIBLE OR HIDDEN HINGES
- ⑨ SAFETY CYLINDER
- Ⓞ ANTI-LEVER SYSTEM



MOD. LO5



**HÉRCULES**  
Colour: Resin brass  
Finish: Spatula  
Accessory: ÚNICA 2

## OPENING SYSTEMS

### FINGERPRINT SCANNER

- Up to 20 users
- Light ring to signal system feedback and operating modes
- Can be installed in the door leaf or in the door handle
- Available in stainless steel gray or black
- Freedom to leave the house and open the door without having to carry the key, smartphone, card, etc.
- Highest security: only authorised persons can unlock the door
- Highest level of counterfeit protection
- Recognizes the growth of children's fingers and changes in user habits as well as minor injuries
- Temporary access authorizations possible
- Access log shows all activities of the last 30 days
- Possibility of unlocking the door, via smartphone, from anywhere
- Message to the smartphone when opening the door
- Connection with the Alexa virtual assistant from Amazon



### OPENING BY CODE OR BLUETOOTH

- Option to open by code on your touch screen
- Option to open from the mobile phone via Bluetooth (with touch confirmation on optional keyboard)
- The door unlocks and opens automatically
- In case of an obstacle detection, the door stops
- Once closed, the lock is automatically locked
- Control of functions through a mobile application compatible with iOS and Android (lighting, tone, temporary user blocking ...)

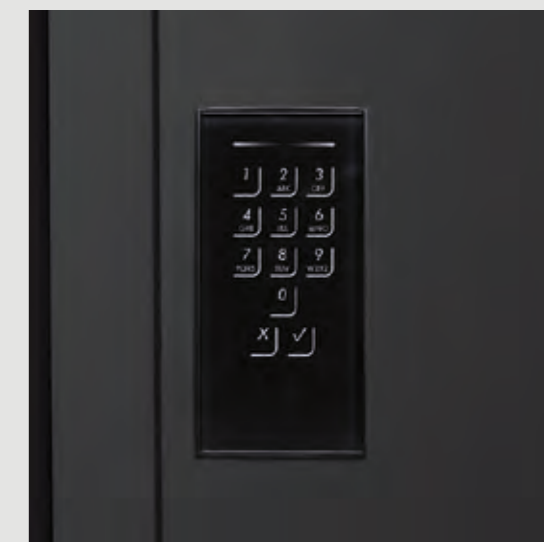

### MOTORIZED OPENING

- Hinged door system with easy access
- It allows to open and close doors automatically
- Activated by push button, remote control or acoustic signals
- Barrier-free system, ideal for people with reduced mobility (slow speed mode)
- Stops and reverses if an obstacle is encountered
- The mechanism is invisible when the door is closed, once it is integrated into the frame
- Manual, automatic or pushing option
- Maximum door width: 1,100 mm
- Maximum door weight: 125 kg





ACCESSORIES



**AVPLUS 12**

Colour: RAL\_7016  
Glass type: Matt  
Accessory: 140  
Details: Stainless steel



**ELECTRONIC SPYHOLE**

- 3.2 inch digital spyhole
- Good visibility even in low light conditions
- 105° viewing angle
- Easy installation and handling
- For panels from 24 to 100 mm thick
- Battery: 2x AAA batteries



**FRESNO**

Colour: RAL\_7021  
Glass type: Matt  
Accessory: 123  
Details: Embero woodgrain piece



Detail woodgrain piece TARACEA collection



**DIGITAL WIRELESS SPYHOLE**





















- Control and visualization through mobile application
- 2 inch screen
- 105° viewing angle
- Photo and video mode
- Easy installation and handling
- For panels from 38 to 100 mm thick
- Rechargeable lithium battery

KNOBS



**CARINA**  
Colour: Foil EF1541083  
Glass type: Matt  
Accessory: UNICA 11  
Details: Glass piece

The **glass** piece takes a leading role in this design, achieving an exceptional gloss in black, enhanced by the geometric fitting with the accessory

 PM 1_Satin steel Ø65 mm	 PM 1_Copper	 PM 1_Golden	 PM 1_Black
 PM 2 - Satin steel * Ø70 mm	 PM 3_Satin steel 90x50 mm	 PM 4 - Satin steel * Ø100 mm Ø200 mm	 PM 5 - Satin steel * Ø50 mm
 PM 6_Satin steel Ø50 mm	 PM 7 - Satin steel * Ø50 mm	 PM 8 - Satin steel * Ø50 mm	 PM 9 - Satin steel * Ø50 mm
 PM 10_Satin steel 100x400 mm	 PM 11_Satin steel 100x200 mm	 PM 12 - Satin steel * 70 mm	 PM 13 - Satin steel * 50x50 mm
 PM 14 - Satin steel * 70x70 mm	 PM 15 - Satin steel * 46 mm	 PM 16 - Camel natural leather * - Brown natural leather - Black natural leather Ø50 mm	 PM 17 - Black * - White - Nickel - Slate stone

LEVER HANDLE

SQUARE COLLECTION

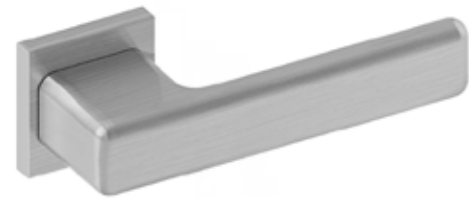

SQ 1\_Satin steel

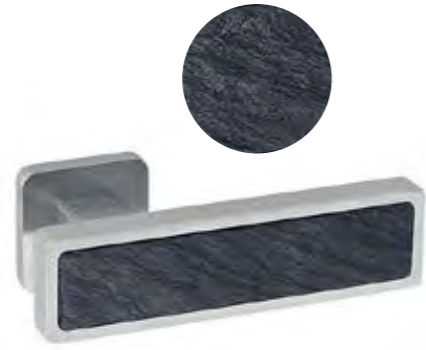

SQ 2 - Slate stone \*  
- Black aluminium  
- White aluminium  
- Nickel aluminium

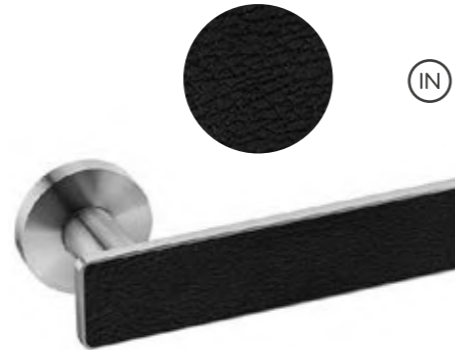

SQ 3 - Black natural leather \*  
- Camel natural leather  
- Brown natural leather



TB 4 - Brown natural leather \*  
- Black natural leather



TB 5 - Black natural leather \*  
- Camel natural leather  
- Brown natural leather

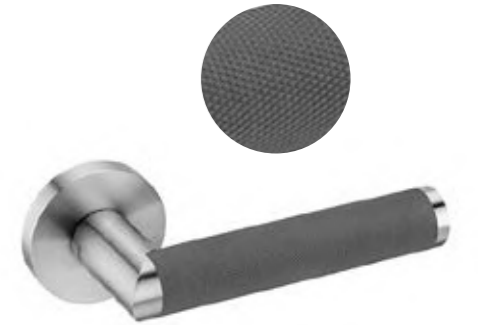

TB 6 - Grey \*  
- Brass  
- Steel



SQ 4\_Satin steel



SQ 5\_Satin steel



SQ 6\_Satin steel

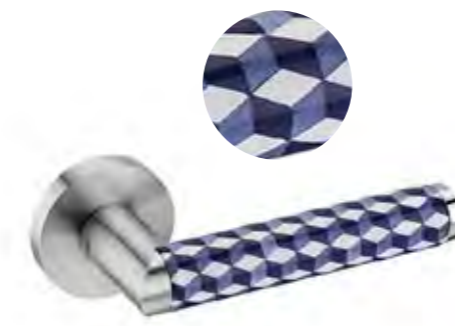

TB 7 - Cubic ceramic \*  
- Blue ceramic  
- Black ceramic  
- White ceramic



TB 8\_Satin steel

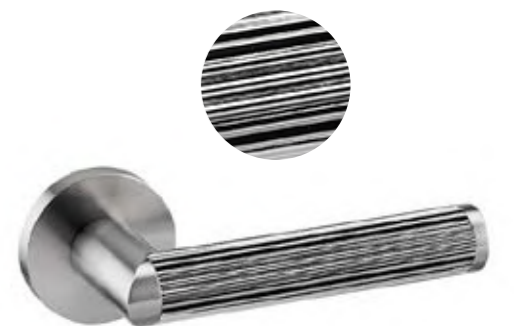

TB 9\_Steel and silver



SQ 7\_Satin steel



SQ 8 - Black aluminium \*  
- Bright grey aluminium  
- Dark grey aluminium  
- White aluminium  
- Bright aluminium  
- Satin aluminium



SQ 9\_Satin steel



SQ 10 - Black \*  
- Steel



TB 10\_Steel and silver



TB 11\_Steel and silver



TB 12\_Wenge natural wood

TUBULAR COLLECTION



TB 1 - Copper \*  
- Black steel



TB 2 - Brown natural leather \*  
- Black natural leather  
- Camel natural leather  
- Satin steel / bright steel



TB 3 - Black \*  
- Chocolate  
- Copper  
- Golden  
- Bright steel



TB 13 - Chocolate \*  
- Steel  
- Black  
- Copper  
- Golden



TB 14 - Anthracite \*  
- Unpolished steel  
- Copper  
- Golden



TB 15 - Golden \*  
- Steel  
- Black  
- Copper  
- Chocolate

LEVER HANDLE

SPECIAL COLLECTION



- SP 1 - Bright chrome \*  
- Bright golden  
- Bright nickel



- SP 2 - Satin chrome \*  
- Bright chrome  
- Nickel  
- Anthracite  
- Golden  
- Bronze  
- Copper



- SP 3 - Bright chrome / Wenge \*  
- Bright chrome / Cherry  
- Bright chrome / Oak  
- Bright chrome / Satin steel  
- Satin chrome / Wenge  
- Satin chrome / Crystal matt  
- Satin chrome / White corian



- SP 4 - Bright chrome \*  
- Satin chrome



- SP 5 - Copper \*  
- Anthracite  
- Bronze  
- Bright chrome  
- Satin chrome  
- Satin steel



- SP 6 - Bronze \*  
- Bright golden  
- Satin golden  
- Bright chrome  
- Satin chrome  
- Satin steel



- SP 7 - Anthracite \*  
- Bronze  
- Bright chrome  
- Satin chrome  
- Satin steel



- SP 8 - Satin nickel \*  
- Bright nickel  
- Satin chrome  
- Bright chrome  
- Satin golden  
- Bright golden  
- Satin steel  
- Bronze  
- Copper  
- Anthracite



- SP 9 - Bright chrome / Brown leather \*  
- Bright chrome / Ivory leather  
- B. chrome / Dark brown leather  
- Bright chrome / Blue leather  
- Bright chrome / Green leather  
- Bright chrome / Black leather



- SP 10 - Bright golden / Blue crystal \*  
- Bright golden / Amber crystal  
- B. golden / Transparent crystal  
- Bright chrome / Blue crystal  
- Bright chrome / Amber crystal  
- B. chrome / Transparent crystal  
- Matt chrome / Matt crystal



- SP 11 - Bright golden / Crystal \*  
- Anthracite / Crystal  
- Bright chrome / Crystal  
- Satin chrome / Crystal



- SP 12 - Bright chrome / White \*  
- Satin chrome / White  
- Bright chrome / Black  
- Satin chrome / Black

(IN)

(IN)

(IN) No outdoor treatment



**MISURI**  
Colour: RAL\_7013  
Glass type: Transparent edge matt  
Accessory: 128  
Details: Stainless steel sheet

BAR HANDLE



**MIÑO**  
Colour: RAL\_7005  
Glass type: Transparent edge matt  
Accessory: 251  
Details: Grooves and stainless steel

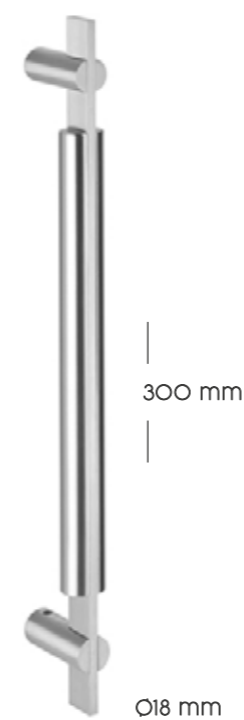

MA 1\_Satin steel

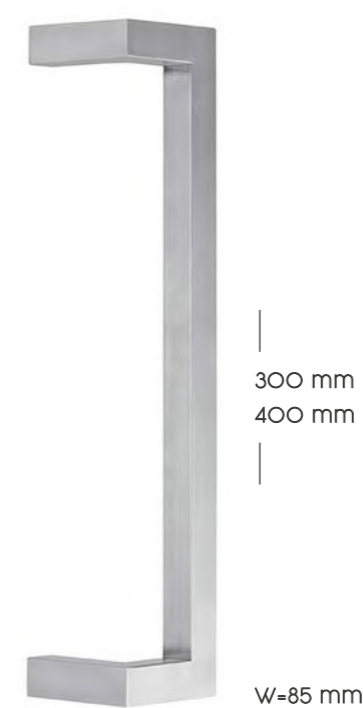

MA 2 - Satin steel \*



MA 3 - Satin steel \*

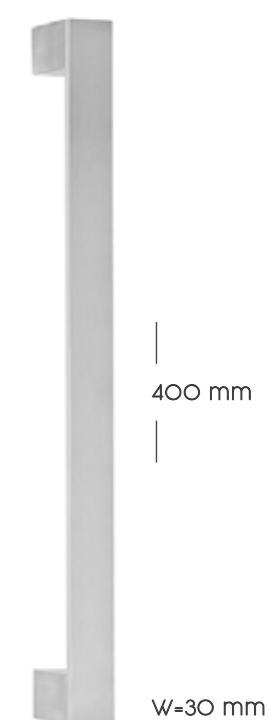

MA 4 - Satin steel \*  
- Bright steel

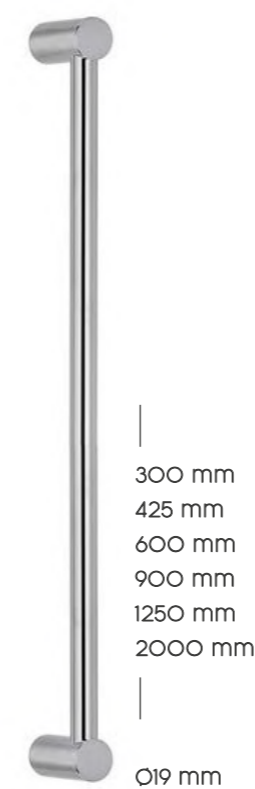

MA 5 - Satin steel \*



MA 6\_Wenge natural wood

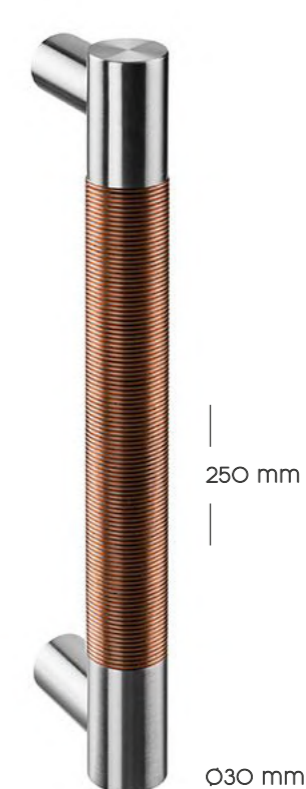

MA 7 - Satin steel / Copper \*  
- Chocolate / Copper  
- Black / Copper  
- Golden / Copper

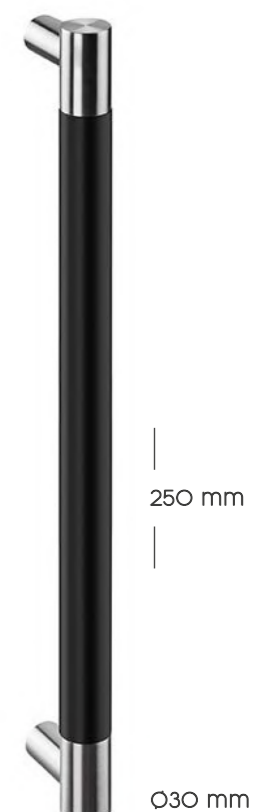

MA 8 - Satin steel \*



BAR HANDLE

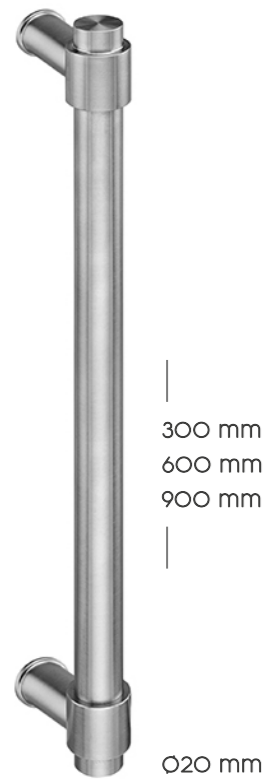

300 mm  
600 mm  
900 mm

Ø20 mm

MA 9 - Satin steel \*



300 mm  
350 mm  
400 mm  
600 mm

Ø30 mm

MA 10 - Satin steel \*



425 mm  
600 mm  
1250 mm

Ø25 mm  
Ø30 mm  
Ø35 mm

MA 11 - Satin steel \*



425 mm  
600 mm  
1250 mm

Ø25 mm  
Ø30 mm  
Ø35 mm

MA 12 - Satin steel \*

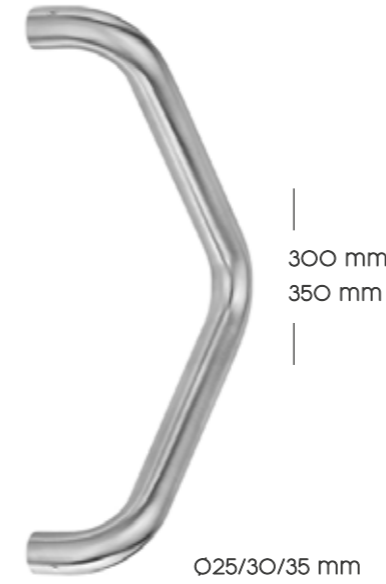

300 mm  
350 mm

Ø25/30/35 mm

MA 17 - Satin steel \*

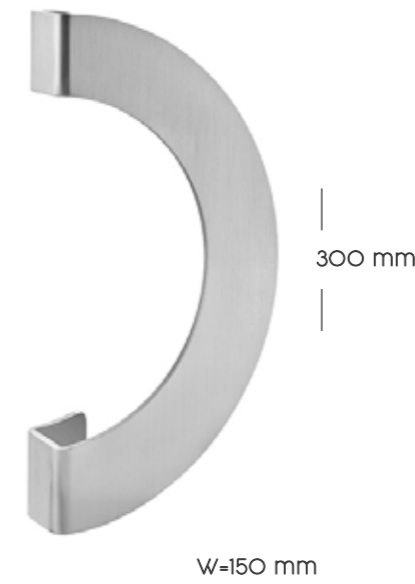

300 mm

W=150 mm

MA 18 - Satin steel \*



300 mm

Ø19/25/30 mm

MA 19 - Satin steel \*

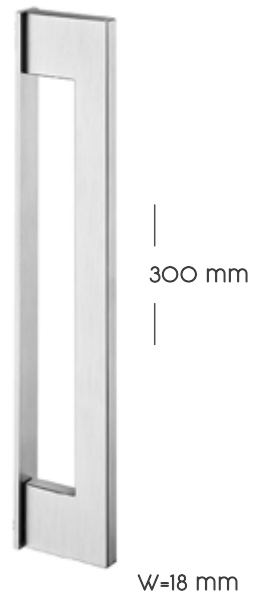

300 mm

W=18 mm

MA 20 - Satin steel \*



550 mm

W=40 mm

MA 13 - Satin steel \*

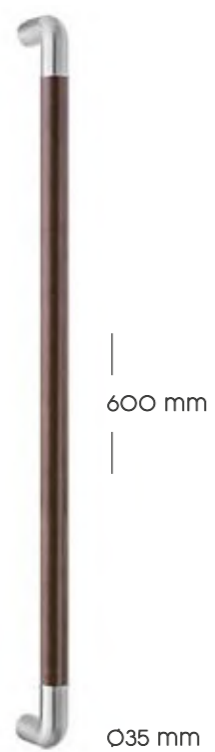

600 mm

Ø35 mm

MA 14\_Satin steel / Copper

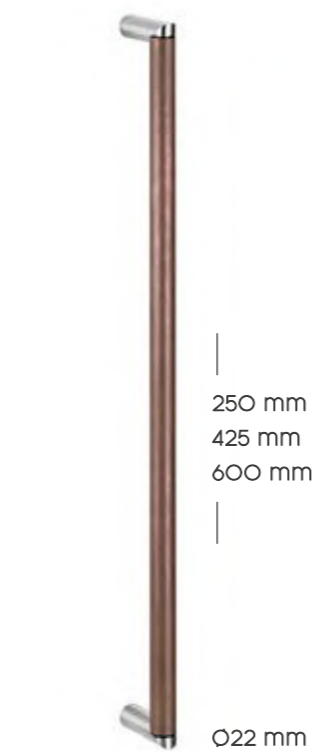

250 mm  
425 mm  
600 mm

Ø22 mm

MA 15\_Satin steel / Copper



740 mm

Ø35 mm

MA 16\_Satin steel / Copper

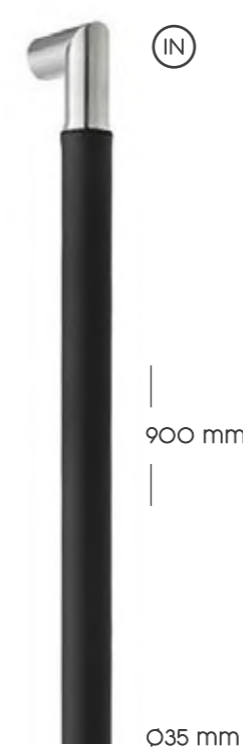

IN

900 mm

Ø35 mm

MA 21 - Black natural leather \*  
- Camel natural leather  
- Brown natural leather



IN

900 mm

Ø35 mm

MA 22 - Brown natural leather \*  
- Camel natural leather  
- Black natural leather



IN

1940 mm

Ø35 mm

MA 23 - Camel natural leather \*  
- Brown natural leather  
- Black natural leather

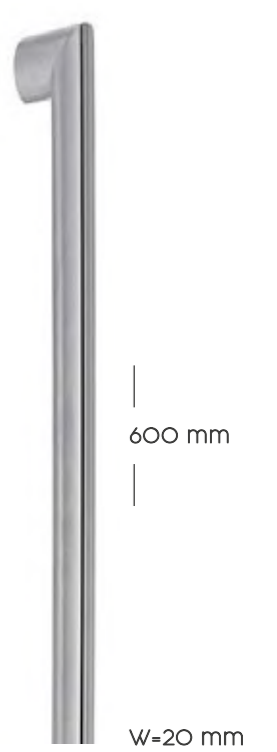

600 mm

W=20 mm

MA 24 - Satin steel \*



KEYHOLES



BOC 1\_Steel - Golden - Copper - Black - Chocolate



BOC 2\_Satin steel



BOC 3\_Satin steel



BOC 4 - Satin steel \*



BOC 5\_Satin steel



BOC 6 - Satin steel \*



BOC 7\_Satin steel



BOC 8 - Satin steel \*



BOC 9 - Satin steel \*



BOC 10 - Satin steel \*



BOC 11 - Satin steel \*



**OLIVO**  
Colour: RAL\_7016  
Glass type: Matt  
Accessory: 124  
Details: Cherry woodgrain piece

## HINGES



### VISIBLE HINGE

- Two-body hinge
- Leaf weight: up to 100 kg (with 3 hinges)
- Economical option



### HIDDEN HINGE 1

- For doors with high aesthetic requirements
- Adjustable in four directions
- Leaf weight: up to 120 kg (with 3 hinges)
- Maximum opening angle 105° (requires floor stop from 95°)
- High security level
- Maintenance-free
- Includes thermal break



### HIDDEN HINGE 2

- Best highlighting of the door design
- Neutral colours: black or silver
- Leaf weight: up to 140 kg (with 3 hinges)
- Maximum opening angle 110°
- Frame material: aluminum
- Long service life: 400,000 opening cycles
- Corrosion resistance DIN EN 1670
- Maintenance-free (self-lubricating bushing)
- No heat loss (continuous sealing)

## CYLINDER LOCKS AND SECURITY SYSTEMS



### STANDARD SAFETY CYLINDER

- Double profile
- Flat nickel-plated brass key with 6 pistons
- Anti-drill bar in the cylinder body
- 30° DIN cam
- Property card
- Standard security level

### HIGH SAFETY CYLINDER

- Double nickel-plated European profile
- Double function (opening with key inserted)
- Encryption with 14 pistons
- Reversible nickel silver key
- Registered and protected key profile
- Bumping resistant
- Drill protection on body and rotor
- Stainless steel encryption pistons
- Anti-extraction bar
- 30° DIN cam
- Property card

### HIDDEN ANTI-LEVER SYSTEM

- Anti-lever safety lock with double reinforcement hinge

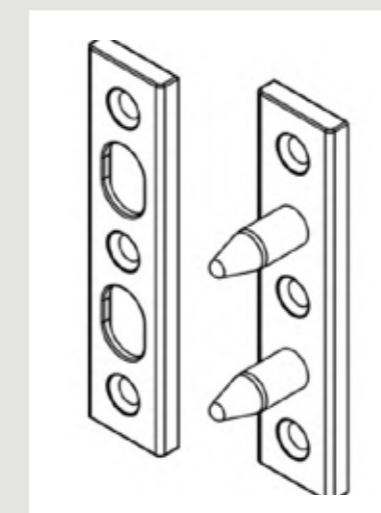
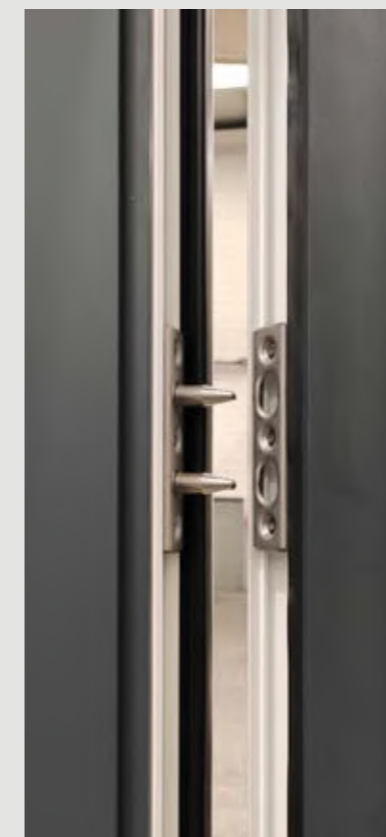

### HIDDEN DOOR CLOSER

- Integrated door closers are fully housed inside the door leaf. The sliding guide is only visible when the door is opened. The strength and speed of closing, the hydraulic final stroke and the hydraulic damping on the opening can be conveniently adjusted during the installation.

Maximum weight: 130 kg  
Maximum length: 1.100 m  
Maximum opening: 120°



## AUTOMATIC LOCKS



### ENTRY PHONE

Allows a temporary activation of the door, with simple one-handed operation or motorized unlocking



### JÚCAR

Colour: RAL\_3005  
Glass type: Fusing  
Accessory: 253  
Details: Stainless steel and grooves

## AVANT

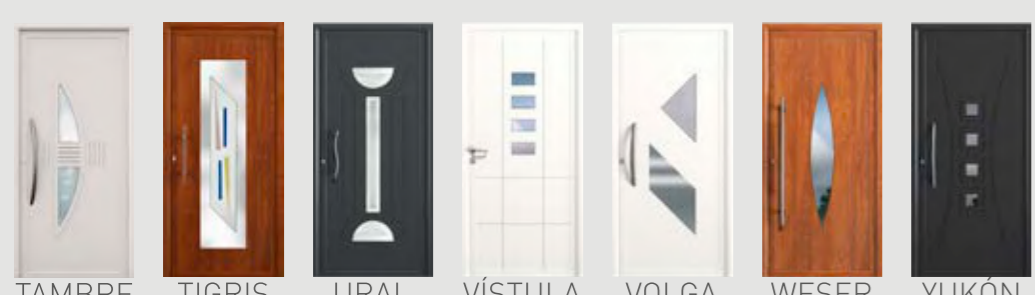
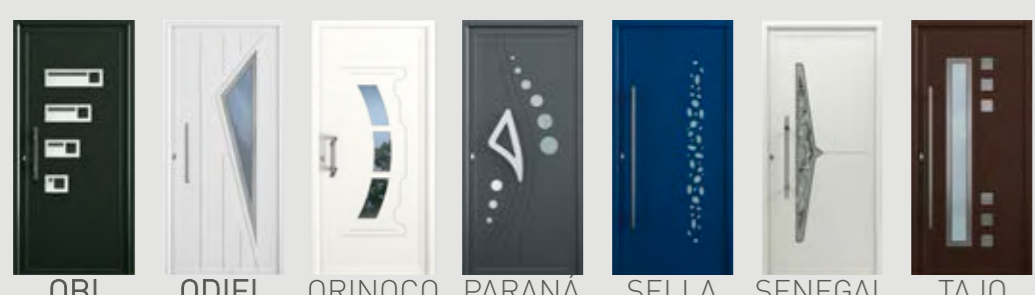
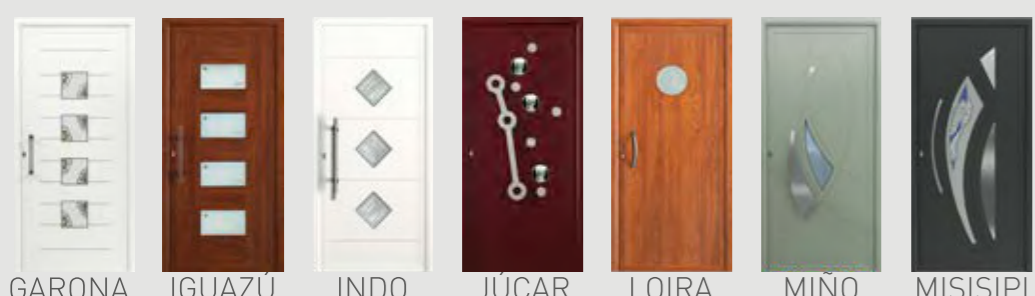
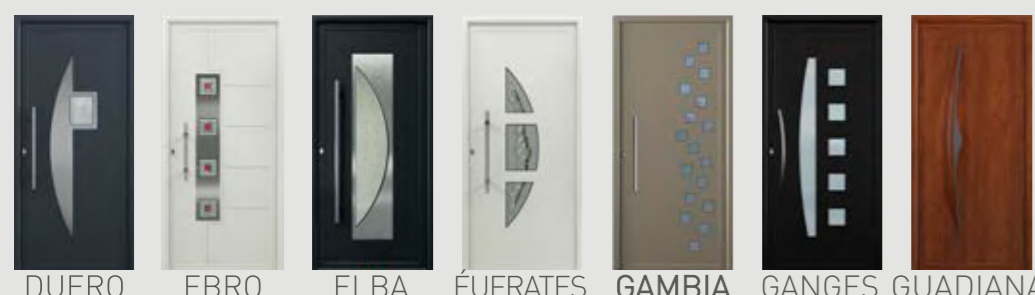

## +LIDO

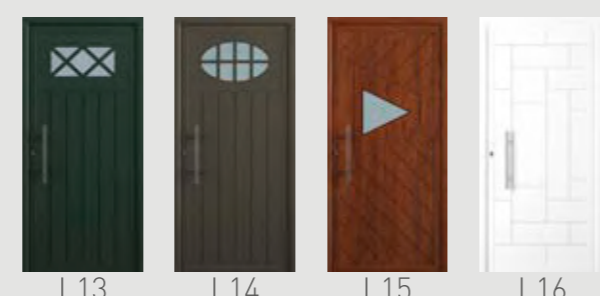

## NATURA



## INNOVA

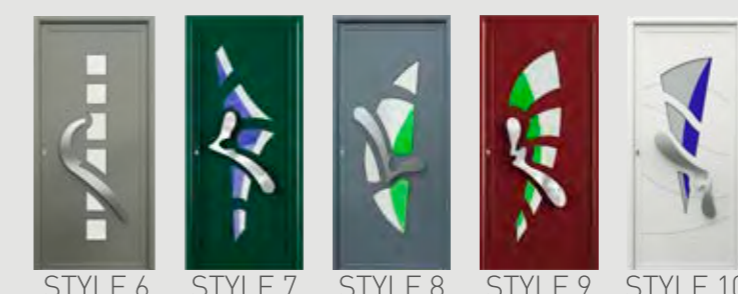

## AVPLUS



## TARACEA



## BÁSICA

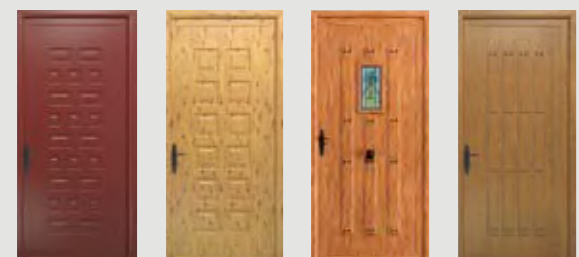

BÁSICA 1 BÁSICA 2 BÁSICA 3 BÁSICA 4

## RÚSTICA



RÚSTICA 1 RÚSTICA 2 RÚSTICA 3 RÚSTICA 4 RÚSTICA 5 RÚSTICA 6



RÚSTICA 7 RÚSTICA 8 RÚSTICA 9 RÚSTICA 10 RÚSTICA 11



VENTANA 1 VENTANA 2 VENTANA 3 POSTIGO IP3C POSTIGO IP7

## CLÁSICA

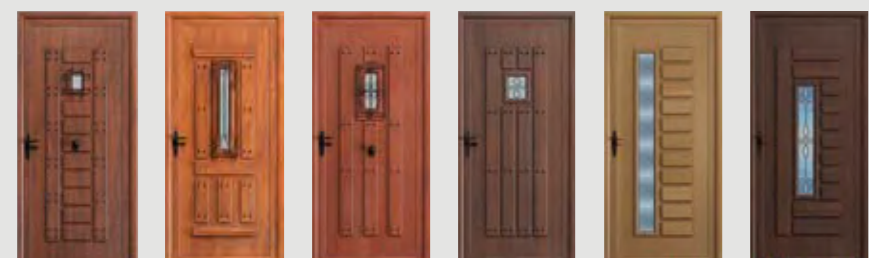

CLÁSICA 1 CLÁSICA 2 CLÁSICA 3 CLÁSICA 4 CLÁSICA 5 CLÁSICA 6



CLÁSICA 7 CLÁSICA 8 CLÁSICA 9 POSTIGOS PLAFONES

## TEMPO



AGUA ALDEBARÁN ALTAR ARA ARGOS

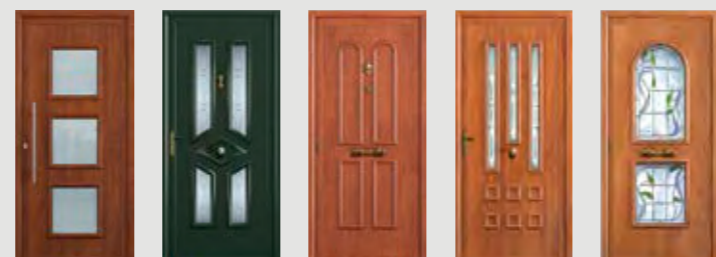

ARTEMIS ATLANTIDAS AURIGA CARRO CINOSURA

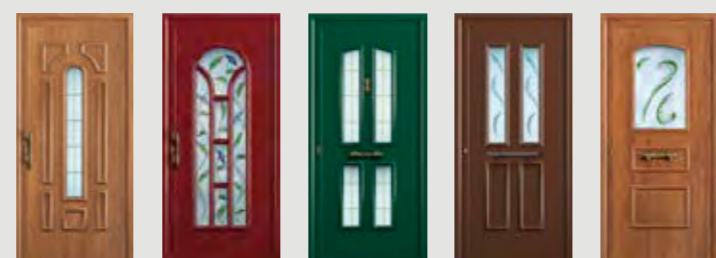

COPA CRUCERO EUROPA HÉLICE HESPÉRIDES

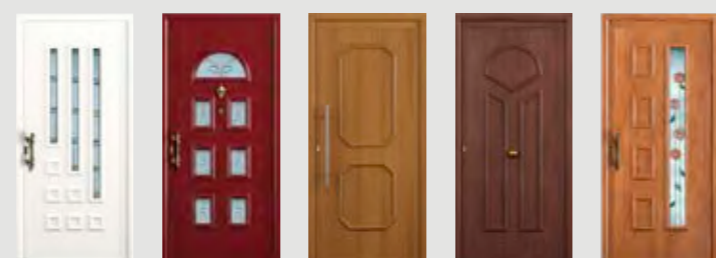

HIADES HIDRA ÍCARO IRIS LIRA

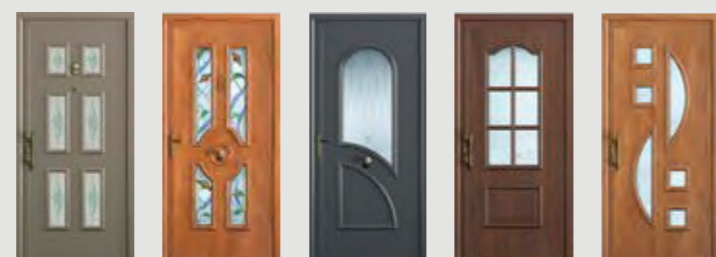

NORTE OFIUCO PAVÓN PLEYADES VELA



VILANO VOLAN

## GLASSES

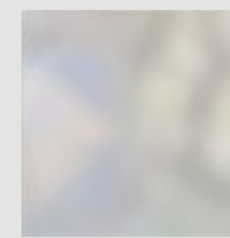

MATT

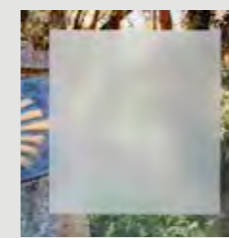

TRANSPARENT  
EDGE MATT

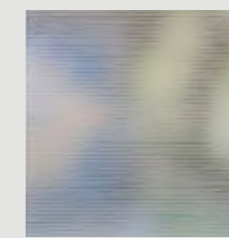

CANNES

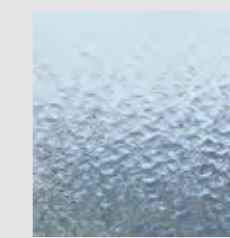

CATHEDRAL

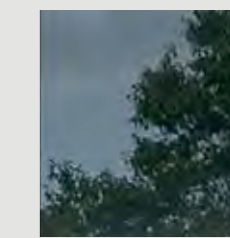

REFLECTIVE



DIAMOND MATT

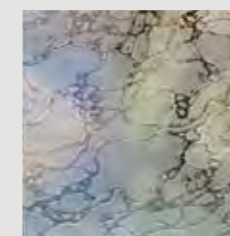

DELTA

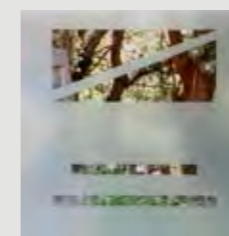

TRANSPARENT  
MATT

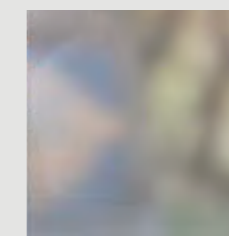

ACID

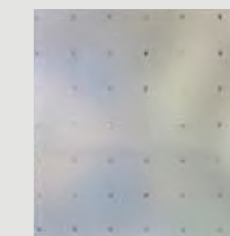

PIXES

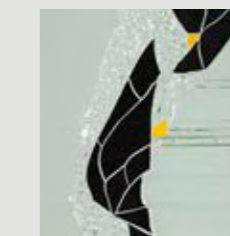

COLOURED  
DIAMOND



FUSSING

Follow us!



Doors & Innovation

[www.indupanel.es](http://www.indupanel.es)

[web@indupanel.es](mailto:web@indupanel.es)

+34 981 68 55 67







Polígono Industrial O Acevedo  
15185 Cerceda, A Coruña (Spain)  
+34 981 685 567



[www.indupanel.es](http://www.indupanel.es)

*Doors & Innovation*