



integral solutions

**ALUMINIUM  
PVC**

# archi tecture

CONTEMPORARY  
ENCLOSURES



**Aluminium and PVC**  
for **architecture**

## INDEX

### 15



#### HINGED

- 16** Cor 80 Industrial Passivhaus
- 17** Cor 80 Industrial
- 20** Cor 80 Hidden Sash
- 22** Cor 70 Industrial
- 24** Cor 70 Hidden Sash
- 26** Cor 70 OC
- 27** Cor 70 OC Half - Hidden sash
- 30** Alu-Steel
- 32** Cor 60
- 34** Cor 60 Hidden Sash
- 35** Cor 3500
- 36** Cor 3000
- 38** Cor 2000
- 39** Cor 2300
- 40** Cor 70 C16 ST
- 42** Cor 70 Hidden Sash C16 ST
- 44** Cor 3500 C16 ST
- 46** Cor Urban C16
- 48** Cor Galicia Premium C16
- 50** Cor 70 CC16
- 52** Cor 70 Hidden SashCC16
- 53** Cor 60 CC16
- 54** Casement

### 57

#### DOORS

- 58** Millennium Plus 80 Door
- 59** Millennium Plus 70 Door
- 60** Millennium Plus Door Pivot
- 64** Panelled Door
- 66** Millennium FR Door
- 67** Millennium 2000 Door
- 68** Millennium Sliding Automatic Door
- 70** Bi-Fold

### 73

#### SLIDING

- 74** Cor Vision Plus
- 78** Cor Vision
- 80** 4600 HI Lift & Slide
- 81** 4500 Lift & Slide / Standard Slide
- 84** 4700 Sliding
- 86** 4900 HI Sliding
- 88** 4200 Sliding
- 90** 5000 Double Sliding
- 91** 5000 Sliding / Integral Sliding
- 92** Mediterranean Balcony
- 94** 2000 Perimetral Sliding
- 95** 6200 Sliding
- 96** 6500 Sliding
- 97** 6500 Plus Sliding

### 101

#### PVC

- 102** A 84 Passivhaus HI
- 103** A 84 Passivhaus 1.0 Thermally broken / A 84 Passivhaus 1.0
- 104** A 84 Hinged
- 107** A 84 Hidden Sash Passivhaus / A 84 Hidden Sash
- 108** A 70 Hinged
- 109** A 70 Hinged Triple Seal
- 112** Alcover
- 114** C 70 Sliding
- 116** E 170 Lift & Slide
- 118** Cortizo Isolation Shutter Box

### 121

#### FAÇADE SYSTEMS

- 122** Engineering for Building Envelopes
- 124** Modular Façade
- 127** Light Façades
- 131** TP 52 Façade
- 132** SG 52 Façade
- 134** TPH 52 Façade
- 136** TPV 52 Façade
- 138** ST 52 Façade
- 139** SST 52 Façade
- 142** Equity Façade
- 144** Skylight - Veranda
- 146** Sliding Roof

### 149

#### INTERIOR DIVISIONS

- 151** PW80 Office Partition Wall

### 153

#### SOLAR PROTECTION

- 154** Solar Protection Louvres
- 155** Decorative Lattices & Louvres
- 158** Tamiz
- 159** Mallorquina

### 163

#### BALUSTRADE

- 164** View Crystal Balustrade / View Crystal Plus Balustrade
- 166** Classic Balustrade
- 168** Juliet Balcony

### 171

#### ACCESSORIES



# CORTIZO

## GLOBAL PRODUCTION CAPACITY



CORTIZO, an international leader in the design and manufacture of aluminium and PVC. Our production capacity consists of 150.000 t of aluminium and 45.000 t of PVC. This enables us to meet the requirements of our customers across the 60 countries in which we are currently present.

### U value chart



### ALUMINIUM

SISTEM	Uf W/m²K	Uw W/m²K
Cor 80 Industrial Passivhaus	0,94	From 0,66
Cor 80 Industrial	1,3	From 0,8
Cor 80 Hidden Sash	1,4	From 0,8
Cor 70 Industrial	1,6	From 0,9
Alu-Steel	1,7	From 0,83
Cor 70 CC16	1,7	From 0,8
Millennium Plus 80 Door	1,7	From 0,8
Cor 70 C16 ST	1,7	From 0,9
Cor 70 Hidden Sash C16 ST	1,83	From 1,0
Cor 70 OC Half - Hidden sash	1,8	From 1,0
Cor 70 OC	1,9	From 1,0
Cor 70 Hidden Sash	2,0	From 1,0
Cor Galicia Premium C16	2,1	From 1,1
Cor 60 CC16	2,2	From 0,9
Cor 70 Hidden Sash CC16	2,2	From 1,3
Cor Urban C16	2,3	From 1,2
Millennium FR Door	2,4	From 1,4
Millennium Plus 70 Door	2,5	From 0,9
Cor 3500 C 16 ST	2,7	From 1,2

Consult typology, dimensions and glazing.  
Consult transmittance of different joints.

SISTEM	Uf W/m²K	Uw W/m²K
Cor 3500 Hinged	2,3	From 1,0
Casement	2,7	From 1,0
4900 HI Sliding	2,7	From 1,2
Cor 60 Hinged	2,8	From 1,0
Bi-Fold	3,1	From 1,1
4600 HI Lift & Slide	3,1	From 0,9
Cor 3000 Hinged	3,4	From 1,3
Cor 60 Hidden Sash Hinged	3,6	From 1,5
Cor Vision Plus Sliding	3,8	From 0,9
Cor Vision Sliding	3,9	From 1,3
4500 Lift & Slide	4,0	From 1,5
4700 Sliding	4,0	From 1,1
4200 Sliding	4,0	From 1,5
5000 Double Sliding	4,0	From 1,3
Cor 2000 Hinged	5,7	From 1,8
Cor 2300 Hinged	5,7	From 2,0
6200 Sliding	5,7	From 3,2
Millennium 2000 Door	5,7	From 2,3
Mediterranean Balcony	5,7	From 2,1
2000 Perimetral Sliding	5,7	From 2,9
5000 Sliding	5,7	From 2,3
6500 Sliding	5,7	From 2,2
6500 Plus Sliding	5,7	From 2,0

### // Completed projects



### PVC

SYSTEM	Uf W/m²K	Uw W/m²K
A 84 Passivhaus HI Hinged	0,76	From 0,66
A 84 Passivhaus 1.0 Hinged	1,01	From 0,74
A 84 Passivhaus 1.0 Reduced Reinforcement Hinged	1,00	From 0,74
A 84 Hidden Sash Passivhaus	1,05	From 0,71
A 84 Hidden Sash	1,11	From 0,74
A 84 Hinged	1,16	From 0,79
A 70 Hinged	1,3	From 0,9
A 70 Hinged Triple Joint	1,3	From 0,9
C 70 Sliding	1,8	From 1,3
E 170 Lift & Slide	1,6	From 0,9

Consult typology, dimensions and glazing.  
Consult transmittance of different joints.

\_ Quality Edvard Grieg Hotel  
LINK ARKITEKTUR // EMIMAR  
Norway

SHUTTER BOX	W/m²K
	<b>U<sub>sb</sub> SHUTTER BOX</b>
Cortizo Isolation Shutter Box	0,66



\_ Hotel K 23  
Cuba



\_ Duo Towers  
France



\_ Altower  
Turkey

investigation, advancement and quality



CORTIZO IS QUALITY

The quality of all CORTIZO products is based on the strict tests carried out in official, national and international laboratories, as well as by our technical staff in our own test benches.

R+D

Design, innovation and quality are the protagonists in the more than 80 window, door, façade, composite panel, balustrade and solar protection systems designed by our R&D department. CORTIZO enclosures adapt to the climate and construction particularities of thousands of projects around the world. Single-family and collective housing, hospitals and health centres, hotels, administrative buildings, infrastructures, sports centres, commercial and industrial spaces, social and cultural centres...

The adequate selection of raw materials and the control of all parameters that influence the extrusion process, backed by the ISO 9001 international certification, guarantee the quality of the extruded material. Additionally, the meticulous work in the execution of the surface treatments has allowed us to obtain the most demanding European quality certificates, such as QUALICOAT, QUALIDECO and QUALICOAT SEA SIDE for the laquering process, and the EWWA-EURAS for the anodizing process.





## CORTIZO LAB

The Cortizo LAB software allows for the immediate production of calculations, test results and classifications of all enclosure systems designed by CORTIZO and tested in its Technological Centre, for any dimension, typology and glazing (windows, doors, double joinery, façades, roofs and louvres).

**Thermal performance**

**Acoustic performances**

**AEV Tests:**

- Window and door systems: EN 12207 / EN 12208 / EN 12210

- Façades: EN 12152 / EN 12154 / EN 13116

**Microventilation**

**Mechanical Calculations**

Calculation and production of wind and snow load reports

## CORTIZO BIM

Virtual management of enclosure designs

**BIM training**

**Personalized assistance**

**BIM customized solution designs**

Founded on the 3D reproduction of each of the structural elements that make up a building, this technology allows for a more quick and comprehensive parametric design of the projects, offering digital replicas of our enclosure systems. The BIM library incorporates intelligent objects that implicitly carry all the technical, thermal, acoustic and mechanical information, virtually reproducing their behaviour in reality.



## TSAC NETWORK

Personalized technical assistance to architecture professionals in their own geographic working area is a differentiating fact of the CORTIZO spirit. For this purpose, we have a network of 22 Proximity Architecture and Engineering Departments strategically located in different areas in Europe and America.

**Finite Element Method for Structural Computation**

**Documents of compliance with regulations and standards**

**Official tests and certifications from the CORTIZO Technology Centre**

**Design and assessment of customized profiles for each project**

**Resolution of details and meeting on site**

**BIM comprehensive assistance**



Santander Bank Headquarters  
Spain

// Completed projects

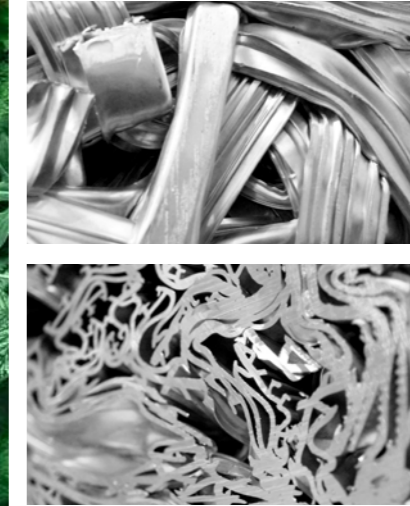

### CORTIZO ECOEFFICIENT

Aluminium life cycle "cradle to cradle".  
Via its two foundries, CORTIZO RECYCLING transforms aluminium waste into raw material for the extrusion of profiles, thus closing the cycle of a 100% reusable material.  
More than 2400 pick-up points of aluminium scrap in Europe.  
Low energy consumption in recycling (only 5% compared to primary consumption).  
Officially certified purifying stations



Green building consultation  
greenbuilding@cortizo.com



contemporary  
enclosures



**hinged** window and door systems

# COR 80

## Industrial Passivhaus

Certified for the warm-temperate category, this system offers exceptional thermal insulation thanks to its special foams on the frame and sash. With a transmittance value  $U_w$  from just  $0.66 \text{ W/m}^2\text{K}$ , it is an ideal solution for buildings with low energy consumption.

European - Groove  
Thermally broken



FEATURES		
Transmittance		$U_w \geq 0,66 \text{ (W/m}^2\text{K)}$
Acoustic insulation		Rw up to 46 dB
Air permeability		Class 4
Water tightness		Class E1950
Wind resistance		Class C5

Reference test 1,23 x 1,48 m / 2 sashes

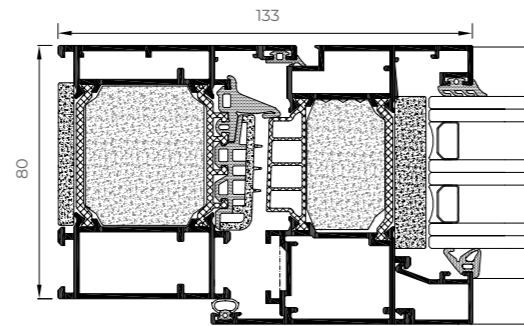

### POSSIBILITIES



### OPENING POSSIBILITIES



#### Inward Opening

Side hung  
Tilt & turn  
Tilt & parallel  
Tilt only



### Sightlines

Frame 80 mm, Sash 88 mm

### Profile Thickness

1,6 mm

### Polyamide Strip Length

45 mm

### Glazing

Max. 65 mm, Min. 25 mm

### Maximum Sash Dimensions

Width (L) 1500 mm, Height (H) 2600 mm

### Maximum Sash Weight

160 kg

Consult maximum weight and dimensions according to typologies.

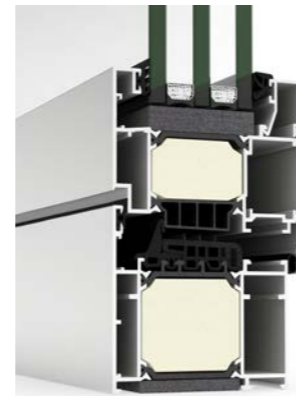

### Aesthetic possibilities:

Sash: Straight / Bead: Straight or curved

# COR 80

## Industrial

With a 80 mm frame depth, the COR 80 Industrial series responds to the most severe climatic requirements thanks to its thermal break with 45 mm tubular polyamide strips and the incorporation of polyolefin both around the glass and between the frame and sash.

European - Groove  
Thermally broken



FEATURES		
Transmittance		$U_w \geq 0,8 \text{ (W/m}^2\text{K)}$
Acoustic insulation		Rw up to 46 dB
Air permeability		Class 4
Water tightness		Class E1950
Wind resistance		Class C5

Reference test 1,23 x 1,48 m / 2 sashes

### POSSIBILITIES



### OPENING POSSIBILITIES

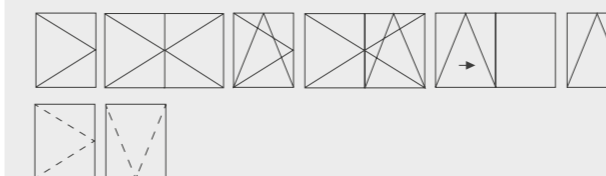

#### Inward Opening

Side hung  
Tilt & turn  
Tilt & parallel  
Tilt only

#### Outward Opening

Side hung  
Top hung

### Sightlines

Frame 80 mm, Sash 88 mm

### Profile Thickness

1,5 mm

### Polyamide Strip Length

45 mm

### Glazing

Max. 65 mm, Min. 25 mm

### Maximum Sash Dimensions

Width (L) 1500 mm, Height (H) 2600 mm

### Maximum Sash Weight

160 kg

Consult maximum weight and dimensions according to typologies.



### Aesthetic possibilities:

Sash: Straight / Bead: Straight or curved

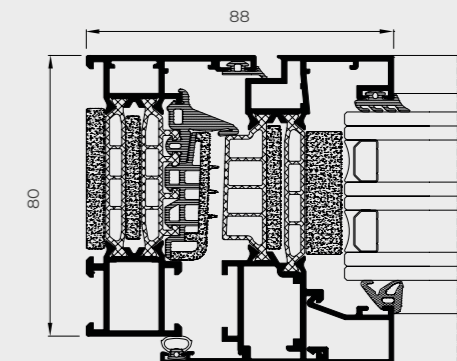



COR 80 INDUSTRIAL



## CORTIZO MINIMALIST HANDLE

Simple lines, avant-garde design

Straight aesthetic

Design without escutcheon

Applicable to all European-Groove hinged series,  
C16, CC16 series and PVC

Specific transmission box (In European-Groove)

Hidden screws

8 mm spindle (In European-Groove)

Dimensions 32 x 148 mm

# COR 80

## Hidden Sash

Elegant design with straight aesthetic in which the sash is concealed behind the frame, thus maximizing the glazed surface and the entry of light. Added to all of this is the great thermal and acoustic performance prompted by the 45 mm thermal break and a glazing capacity of up to 51 mm that allows the installation of triple glazing.

European - Groove  
Thermally broken



### FEATURES

Transmittance		$U_w \geq 0,8$ (W/m <sup>2</sup> K)
Acoustic insulation		Rw up to 46 dB
Air permeability		Class 4
Water tightness		Class E1500
Wind resistance		Class C5

Reference test 1,23 x 1,48 m / 2 sashes



### Sightlines

Frame 80 mm, Sash 80 mm

### Polyamide Strip Length

45 mm

### Profile Thickness

Window 1,9 mm

### Glazing

Max. 51 mm, Min. 36 mm

### Maximum Sash Dimensions

Standard Solution:

Width (L) 1300 mm, Height (H) 2400 mm

### HD Hinges (Side Hung):

Width (L) 1200 mm, Height (H) 3500 mm

### Maximum Sash Weight

160 kg

### POSSIBILITIES



SECURITY HARDWARE



CONCEALED HINGES



CONCEALED HANDLE



CONCEALED DRAINAGE

### OPENING POSSIBILITIES



Inward Opening

Side hung  
Tilt & turn  
Tilt only

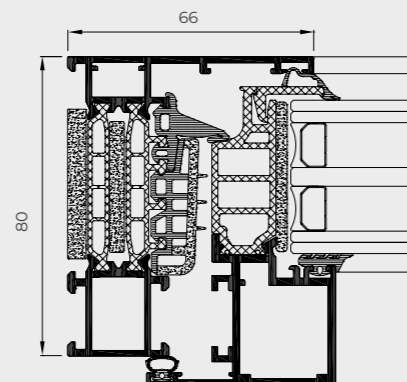

# ARCH INVISIBLE

BY CORTIZO

First *invisible handle* on the market

Exclusive handle integrated within the sash, imperceptible from a frontal view.

Possibility of concealed hinges that consolidates the aesthetic purity of the system.

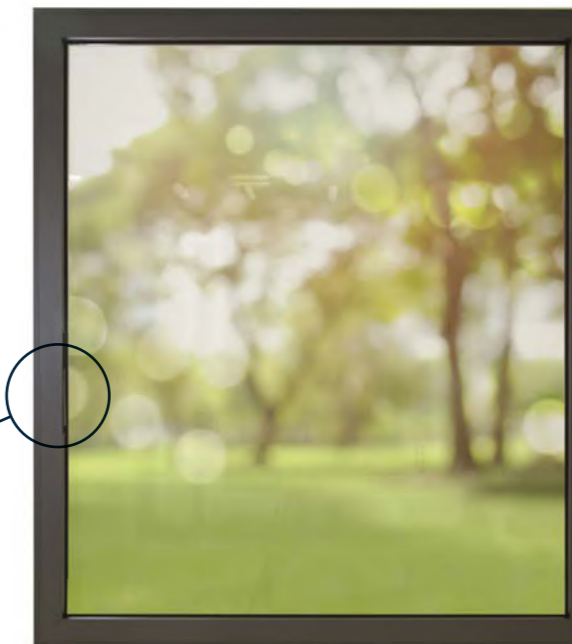
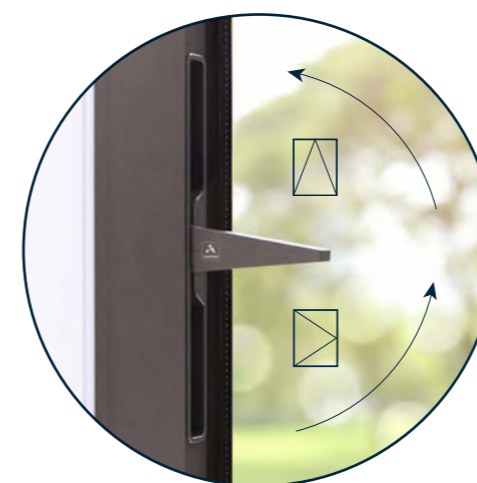

Solution for hidden sash systems COR 80 HS and COR 70 HS.

Dimensions: 27,5 mm (L) x 234 mm (H).

Ergonomics, robustness and easy handling in opening and closing operations. Totally clean aesthetics that simulate a fixed element, when in fact, it is a side hung or tilt & turn opening.



# COR 70

## Industrial

This 70 mm frame depth hinged system offers great thermal and acoustic performance combined with very simple fabrication, which is why it has become one of the most demanded series for aluminium windows, doors and balconies.

European - Groove

Thermally broken



### FEATURES

Transmittance		$U_w \geq 0,9$ (W/m <sup>2</sup> K)
Acoustic insulation		Rw up to 44 dB
Air permeability		Class 4
Water tightness		Class E1200
Wind resistance		Class C5
Burgular resistance		Grade RC2 (WK2)
Security test		PASSED

Reference test 1,23 x 1,48 m / 2 sashes  
 Security test: Reference test 1,100 x 2,400 m / 1 sash  
 Burgular test 1,47 x 2,52 m / 1 sash with EVO SECURITY hardware  
 CSTB Laboratory DTA Certification



\* Concealed drainage solution

### POSSIBILITIES

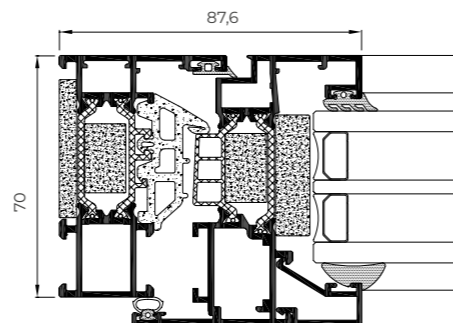

### OPENING POSSIBILITIES

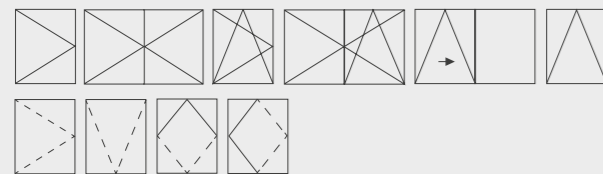

Inward Opening

Side hung  
Tilt & turn  
Tilt & parallel  
Tily only

Outward Opening

Side hung  
Top hung  
Pivoting on horizontal or vertical axis

### COR 70 INDUSTRIAL



### Sightlines

Frame 70 mm, Sash 78 mm

### Polyamide Strip Length

From 32 - 35 mm

### Profile Thickness

Window 1,5 mm

Door 1,7 mm

### Glazing

Max. 55 mm, Min. 15 mm

### Maximum Sash Dimensions

Width (L) 1500 mm, Height (H) 2600 mm

### Maximum Sash Weight

160 kg

### Aesthetic possibilities:

Sash: Straight / Bead: Straight or curved

Consult maximum weight and dimensions according to typologies

# COR 70

## Hidden Sash

It could be a painting, but is a window. This is how we can describe the COR 70 Hidden Sash which, like the 80mm version, has a sightline of only 66 mm and allows the incorporation of the ARCH INVISIBLE handle, concealed hinges and the drainage solution. Any element that breaks the visual harmony of the ensemble is discarded.

European - Groove  
Thermally broken



### FEATURES

Transmittance		$U_w \geq 1,0$ (W/m <sup>2</sup> K)
Acoustic insulation		Rw up to 46 dB
Air permeability		Class 4
Water tightness		Class E1650
Wind resistance		Class C5
Security test		PAS24 PASSED

Reference test 1,23 x 1,48 m / 1 sash  
Security test: Reference test 1,100 x 2,400 m / 1 sash  
CSTB Laboratory DTA Certification

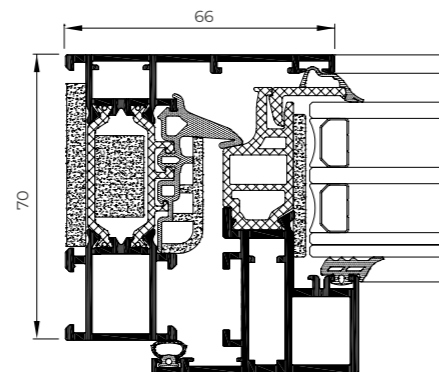

**Sightlines**  
Frame 70 mm, Sash 70 mm  
**Polyamide Strip Length**  
35 mm

**Profile Thickness**  
Window 1,9 mm

**Glazing**  
Max. 40 mm, Min. 26 mm

### Maximum Sash Dimensions

**Standard solution:**  
Width (L) 1300 mm, Height (H) 2400 mm

**HD Hardware (Side Hung):**  
Width (L) 1200 mm, Height (H) 3500 mm

**Maximum Sash Weight**  
160 kg

Consult maximum weight and dimensions according to typologies

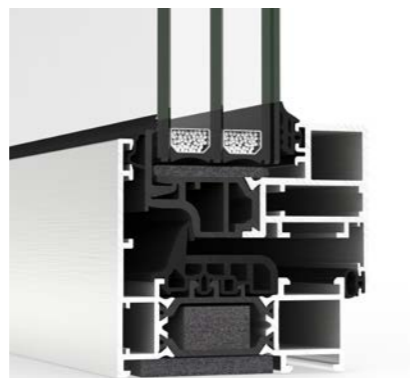

### POSSIBILITIES

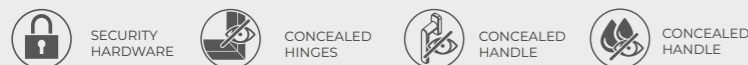

### OPENING POSSIBILITIES



Inward Opening  
Side hung  
Tilt & turn  
Tilt only



COR 70 HIDDEN SASH

## CONCEALED DRAINAGE SOLUTION

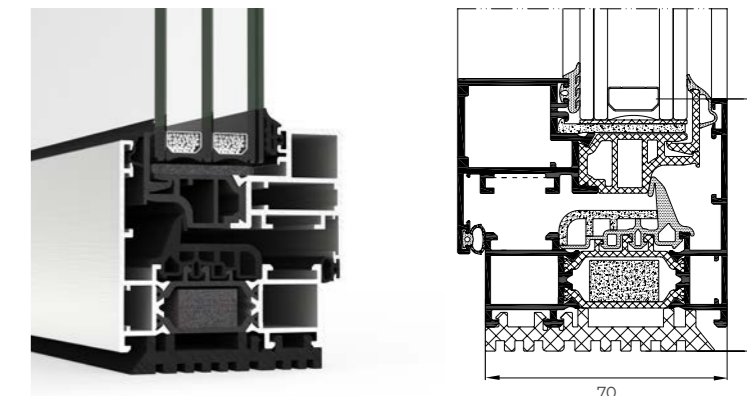

Minimizes the aesthetic impact of the window components.

Compatible with all the 70mm frame depth systems.

It features a gasket at the bottom of the frame to evacuate the water, replacing the face drainage.

Facilitates window fabrication, allowing to place the base of the frame on the site itself.

# COR 70

## OC

Hidden sash system oriented to the French market with monoblock frame that makes installation easier. Using this new frame allows faster fabrication and installation, avoiding overlaps, cills and any other complementary profiles, speeding up assembly and fitting. The fabricator can choose either straight or 45 degree cut.

European - Groove  
Thermally broken

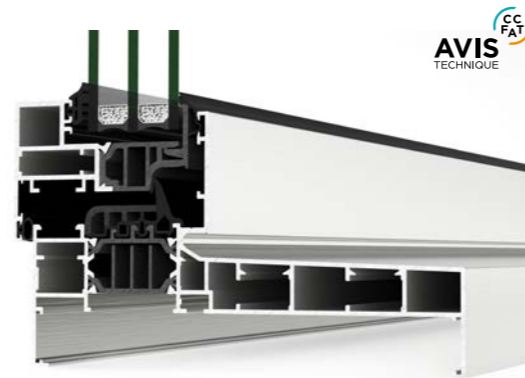

\* Mitered frame

### FEATURES

Transmittance		$U_w \geq 1,0$ (W/m <sup>2</sup> K)
Acoustic insulation		Rw up to 46 dB
Air permeability		Class 4
Water tightness		Class E1650
Wind resistance		Class C5

Reference test 1,23 x 1,48 m / 1 sash  
CSTB Laboratory DTA Certification

### Sightlines

Frame 70 - 232 mm, Sash 70 mm

**Polyamide Strip Length**

35 mm

**Profile Thickness**

Window 1,9 mm

**Glazing**

Max. 40 mm, Min. 26 mm

**Maximum Sash Dimensions**

Standard solution:  
Width (L) 1300 mm, Height (H) 2400 mm

**HD Hardware (Side Hung):**

Width (L) 1200 mm, Height (H) 3500 mm

**Maximum Sash Weight**

160 kg

Consult maximum weight and dimensions according to typologies

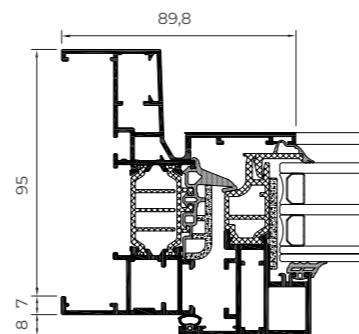

\* Mitered frame

### POSIBILIDADES

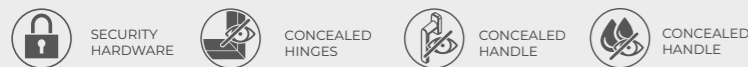

### OPENING POSSIBILITIES



Inward Opening

Side hung  
Tilt & turn  
Tilt only

# COR 70

## OC Half - Hidden sash

The half hidden sash version of the COR 70 OC allows to expand the aesthetic possibilities of this series with monoblock frame available at straight or 45 degree cut.

European - Groove  
Thermally broken

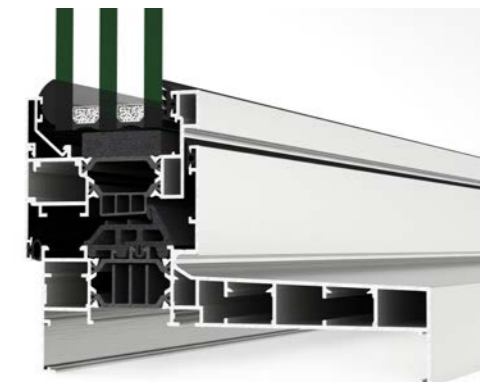

\* Mitered frame

### FEATURES

Transmittance		$U_w \geq 1,0$ (W/m <sup>2</sup> K)
Acoustic insulation		Rw up to 46 dB
Air permeability		Class 4
Water tightness		Class E1800
Wind resistance		Class C5

Reference test 1,23 x 1,48 m / 2 sashes  
CSTB Laboratory DTA Certification

### Sightlines

Frame 70 - 232 mm, Sash 78 mm

**Polyamide Strip Length**

32-35

**Profile Thickness**

Window 1,5 mm

**Glazing**

Max. 55 mm, Min. 15 mm

**Maximum Sash Dimensions**

Width (L) 1000 mm, Height (H) 1700 mm

**Maximum Sash Weight**

160 kg

Consult maximum weight and dimensions according to typologies

### POSIBILIDADES



### OPENING POSSIBILITIES



Inward Opening

Side hung  
Tilt & turn  
Tilt only

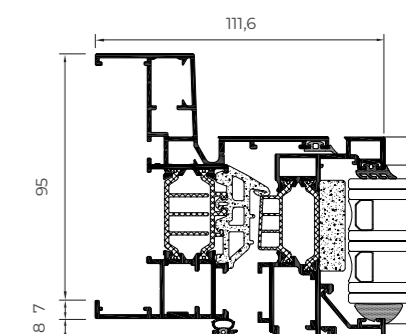

\* Mitered frame

aesthetic possibilities



**COR 70 OC**  
Straight cut frame



**COR 70 OC**  
Mitered frame



**COR 70 OC Half - Hidden sash**  
Straight cut frame



**COR 70 OC Half - Hidden sash**  
Mitered frame





# ALU-STEEL

European - Groove  
Thermally broken



Inspired by classic line designs, the new Alu-Steel system allows to combine aluminium outstanding performances values with a steel-alike appearance. With a sightline of only 72.5 mm, Alu-Steel is the perfect solution for new buildings and refurbishments, offering two different versions, classic or modern.



\*Classic version

\*Modern version

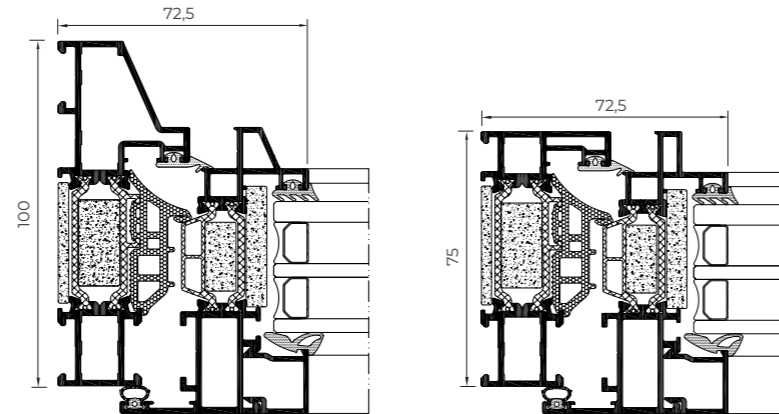

\*Classic version

\*Modern version

## POSSIBILITIES



## OPENING POSSIBILITIES



Inward Opening

Side hung  
Tilt & turn  
Tilt only

## FEATURES

Transmittance		$U_w \geq 0.83 (W/m^2K)$
Air permeability		Class 4
Water tightness		Class E1200
Wind resistance		Class C5

Reference test 1.23 x 1.48 m / 2 sashes

## ALU-STEEL



## Sightlines

Modern frame 75 mm  
Classic frame 100 mm  
Sash 83 mm

## Polyamide Strip Length

32-39 mm

## Profile Thickness

Window 1,5 mm

## Glazing

Max. 54 mm, Min. 20 mm

## Maximum Sash Dimensions

Width (L) 1500 mm, Height (H) 2600 mm

## Maximum Sash Weight

160 kg

Consult maximum weight and dimensions according to typologies

# COR 60

European - Groove  
Thermally broken



Hinged system with 60 mm of frame depth, featuring 24 mm polyamide strips, which provides a notable thermal and acoustic comfort, achieving a noise reduction of up to 48 dB.



### Sightlines

Frame 60 mm, Sash 68 mm

### Polyamide Strip Length

24 mm

### Profile Thickness

Window 1,6 mm

Door 1,6 mm

### Glazing

Max. 46 mm, Min. 5 mm

### Maximum Sash Dimensions

Width (L) 1500 mm, Height (H) 2600 mm

### Maximum Sash Weight

160 kg

Consult maximum weight and dimensions according to typologies.

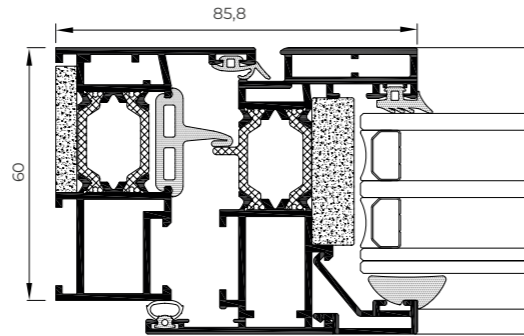

**Aesthetic possibilities:**  
Sash: Straight or curved  
Bead: Straight or curved

### FEATURES

Transmittance		$U_w \geq 1,0$ (W/m <sup>2</sup> K)
Acoustic insulation		Rw up to 48 dB
Air permeability		Class 4
Water tightness		Class E1350
Wind resistance		Class C5

Reference test 1,20 x 1,16 m / 2 sashes

### POSSIBILITIES



SECURITY  
HARDWARE



CONCEALED  
HINGES



ACCESSIBILITY

### OPENING POSSIBILITIES

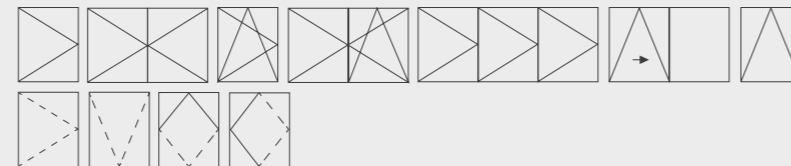

#### Inward Opening

Side hung  
Tilt & turn  
Bi-fold  
Tilt & parallel  
Bottom hung

#### Outward Opening

Side hung  
Top hung  
Pivoting on horizontal or vertical axis.



COR 60

# COR 60

## Hidden Sash

Minimalism for avant-garde projects. It has an interlock profile of only 63 mm, COR 60 Hidden Sash is presented as a hinged system that allows for more glazed surface.

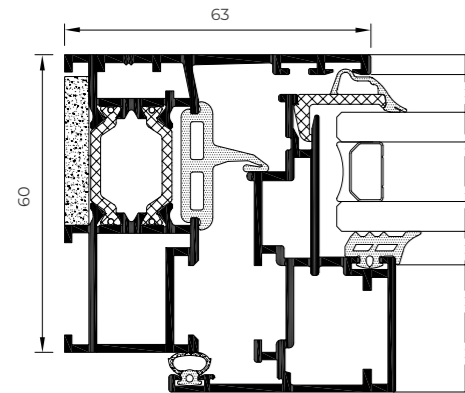

European - Groove  
Thermally broken

### Sightlines

Frame 60 mm, Sash 60 mm

### Polyamide Strip Length

24 mm

### Profile Thickness

Window 1,6 mm

Balcony 1,6 mm

### Glazing

Max. 34 mm, Min. 16 mm

### Maximum Sash Dimensions

Width (L) 1300 mm, Height (H) 2400 mm

### Maximum Sash Weight

160 kg

Consult maximum weight and dimensions according to typologies



### POSSIBILITIES



SECURITY HARDWARE



CONCEALED HINGES

### OPENING POSSIBILITIES



Inward Opening

Side hung  
Tilt & turn  
Bottom hung

### FEATURES

Transmittance   $U_w \geq 1,5 (W/m^2K)$

Acoustic insulation   $R_w$  up to 45 dB

Air permeability  Class 4

Water tightness  Class 9A

Wind resistance  Class C5

Reference test 1,13 x 1,16 m / 1 sash

# COR 3500

Hinged system with a frame depth of 54 mm, a 24 mm thermal break zone, and a maximum glazing capacity of 41 mm. These features grant this system optimal thermal and acoustic performances:  $U_w$  from 1,0  $W/m^2K$ , and up to 46 dB of noise reduction.



### Sightlines

Frame 54 mm, Sash 63 mm

### Polyamide Strip Length

24 mm

### Profile Thickness

Window 1,5 mm

Door 1,7 mm

### Glazing

Max. 41 mm, Min. 5 mm

### Maximum Sash Dimensions

Width (L) 1500 mm, Height (H) 2400 mm

### Maximum Sash Weight

120 kg

Consult maximum weight and dimensions according to typologies

### Aesthetic possibilities:

Sash: Straight or curved

Bead: Straight or curved

### FEATURES

Transmittance   $U_w \geq 1,0 (W/m^2K)$

Acoustic insulation   $R_w$  up to 46 dB

Air permeability  Class 4

Water tightness  Class E1200

Wind resistance  Class C5

Reference test 1,20 x 1,20m / 2 sashes

European - Groove  
Thermally broken

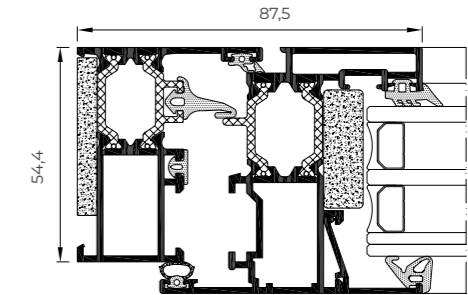

### POSSIBILITIES



SECURITY HARDWARE



CONCEALED HINGES



ACCESSIBILITY

### OPENING POSSIBILITIES

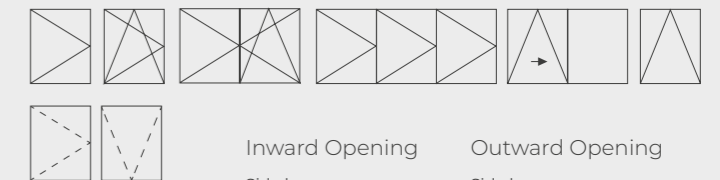

Inward Opening

Side hung  
Tilt & turn  
Bi-fold  
Tilt & parallel  
Bottom hung

Outward Opening

Side hung  
Top hung

# COR 3000

European - Groove  
Thermally broken



Hinged system with a 45 mm frame depth and a thermal break zone of 14,6 mm. This is a versatile system, suitable for mild climates, and with a large variety of opening possibilities.

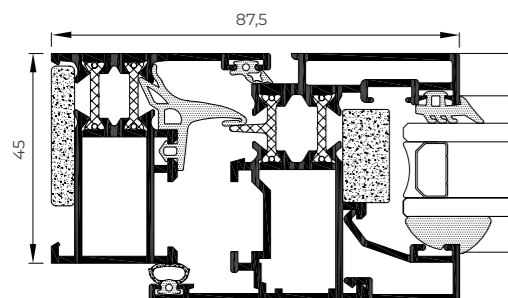

### POSSIBILITIES



SECURITY  
HARDWARE



CONCEALED  
HINGES



### Sightlines

Frame 45 mm, Sash 53 mm

### Polyamide Strip Length

14,6 mm

### Profile Thickness

Window 1,5 mm

Door 1,7 mm

### Glazing

Max. 31 mm, Min. 3 mm

### Maximum Sash Dimensions

Width (L) 1500 mm, Height (H) 2400 mm

### Maximum Sash Weight

120 kg

Consult maximum weight and dimensions according to typologies

### Aesthetic possibilities:

Sash: Straight or curved

Bead: Straight or curved

### OPENING POSSIBILITIES

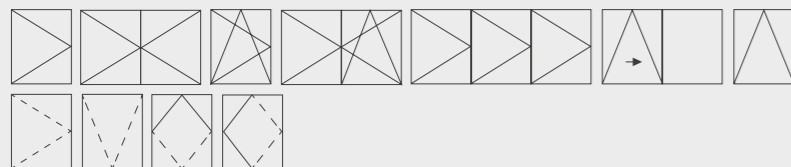

#### Inward Opening

Side hung  
Tilt & turn  
Bi-fold  
Tilt & parallel  
Bottom hung

#### Outward Opening

Side hung  
Top hung  
Pivoting of either horizontal  
or vertical axis

### FEATURES

Transmittance   $U_w \geq 1,3$  (W/m<sup>2</sup>K)

Acoustic insulation   $R_w$  up to 46 dB

Air permeability  Class 4

Water tightness  Class 9A

Wind resistance  Class C5

Reference test 1,18 x 1,18m / 2 sashes



COR 3000

# COR 2000

Euro-groove hinged system with a glazing capacity of 31 mm. Its profile thickness, of 1,5 mm in the window version and 1,7 mm in the door version, provides it with exceptional rigidity and durability.

## FEATURES

Transmittance		$U_w \geq 1,8$ (W/m <sup>2</sup> K)
Acoustic insulation		Rw up to 39 dB
Air permeability		Class 4
Water tightness		Class 9A
Wind resistance		Class C5

Reference test 1,20 x 1,18 m / 2 sashes

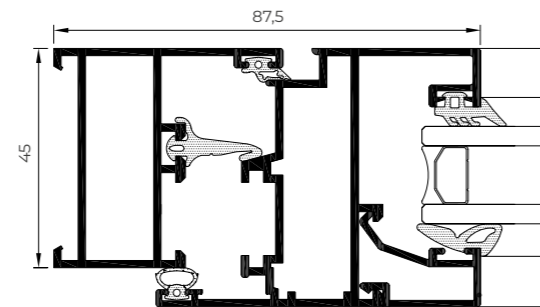

## POSSIBILITIES



## OPENING POSSIBILITIES

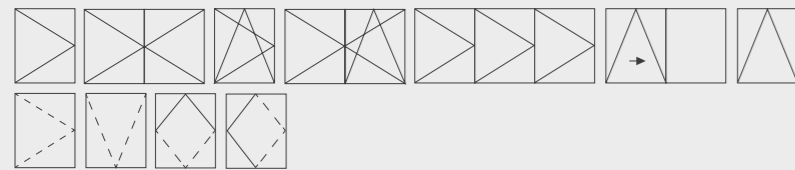

Inward opening

Side hung  
Tilt & turn  
Bi-fold  
Tilt & parallel  
Bottom hung

Outward Opening

Side hung  
Top hung  
Pivoting of either horizontal or vertical axis

## Sightlines

Frame 45 mm, Sash 53 mm

## Profile Thickness

Window 1,5 mm  
Door 1,7 mm

## Glazing

Max. 31 mm, Min. 3 mm

## Maximum Sash Dimensions

Width (L) 1500 mm, Height (H) 2400 mm

## Maximum Sash Weight

120 kg

Consult maximum weight and dimensions according to typologies



## Aesthetic possibilities:

Sash: Straight or curved  
Bead: Straight or curved

European Groove



# COR 2300

Hinged system with a frame depth of 40 mm and a reduced profile thickness.

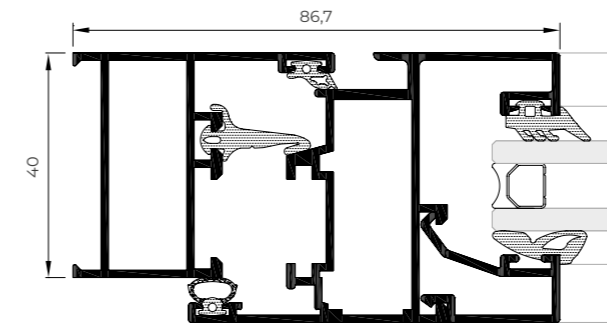

## POSSIBILITIES



## OPENING POSSIBILITIES

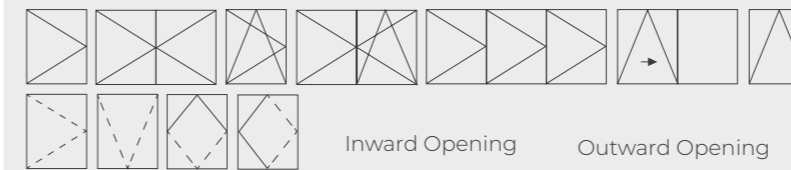

Inward Opening

Side hung  
Tilt & turn  
Bi-fold  
Tilt & parallel  
Bottom hung

Outward Opening

Side hung  
Top hung  
Pivoting of either horizontal or vertical axis

Consult maximum weight and dimensions according to typologies

## FEATURES

Transmittance		$U_w \geq 2,0$ (W/m <sup>2</sup> K)
Acoustic insulation		Rw up to 39 dB
Air permeability		Class 4
Water tightness		Class 9A
Wind resistance		Class C5

Reference test 1,105 x 1,210 m / 2 sashes



## Sightlines

Frame 40 mm, Sash 48 mm

## Profile Thickness

Window 1,3 mm  
Door 1,4 mm

## Glazing

Max. 26 mm, Min. 4 mm

## Maximum Sash Dimensions

Width (L) 1500 mm, Height (H) 2400 mm

## Maximum Sash Weight

120 kg

Consult maximum weight and dimensions according to typologies

## Aesthetic possibilities:

Sash: Straight or curved  
Bead: Straight or curved

European Groove







# COR 70

## C16 ST

Hinged system with a 70 mm frame depth compatible with any standard 16 groove hardware. It features a 35 mm thermal break zone in the frame and 30 mm in the sash, providing it with great thermal and acoustic performance.

16 Grooven  
Thermally broken

### FEATURES

Transmittance		$U_w \geq 0,9$ (W/m <sup>2</sup> K)
Acoustic insulation		Rw up to 46 dB
Air permeability		Class 4
Water tightness		Class E1500
Wind resistance		Class C5

Reference test 1,23 x 1,48 m / 2 sashes

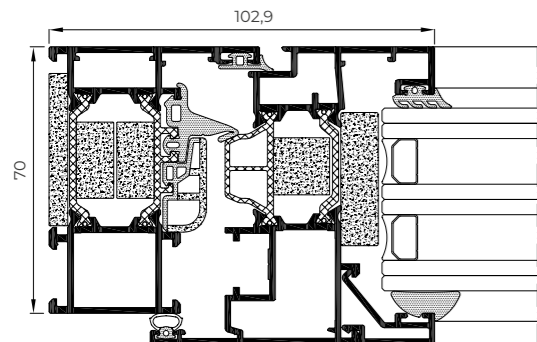

### POSSIBILITIES



### OPENING POSSIBILITIES

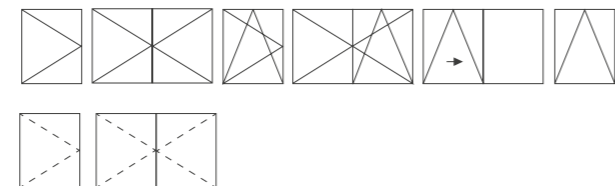

Inward Opening

Side hung  
Tilt & turn  
Tilt & parallel  
Bottom hung

Outward Opening

Side hung (door)



Aesthetic possibilities:  
Sash: Straight  
Bead: Straight or curved

### Sightlines

Frame 70 mm, Sash 78 mm

### Polyamide Strip Length

Frame 35 mm

Sash 30 mm

### Profile Thickness

Window 1,5 mm

### Glazing

Max. 55 mm, Min. 15 mm

### Maximum Sash Dimensions

Width (L) 1500 mm, Height (H) 2600 mm

### Maximum Sash Weight

150 kg

Consult maximum weight and dimensions according to typologies



COR 70 C16 ST

# COR 70

## Hidden Sash C16 ST

16 Grooven  
Thermally broken



Hidden sash hinged system compatible with any standard 16 groove hardware. Its attractive design is based on the concealment of the sash behind the frame, reducing the aluminium interlock profile to up to 73,8 mm. Thus achieving a glazed surface that can reach 85% of the totality of the window's glazing, facilitating the entry of light to the interior of the rooms. Its avant-garde aesthetic is completed with the possibility of concealing the drainage and hinges.

### OPENING POSSIBILITIES



Inward Opening  
Side hung  
Tilt & turn  
Bottom hung

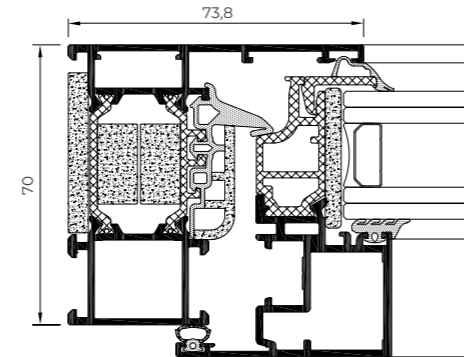

### Sightlines

Frame 70 mm, Sash 70 mm

### Polyamide Strip Length

35 mm

### Profile Thickness

Window 1,6 mm

### Glazing

Fixed light: Max. 40 mm, Min. 27 mm

Window: Max. 34 mm, Min. 24 mm

### Maximum Sash Dimensions

Width (L) 1300 mm, Height (H) 2400 mm

### Maximum Sash Weight

150 kg

Consult maximum weight and dimensions according to typologies

### POSSIBILITIES



SECURITY HARDWARE



CONCEALED HINGES



CONCEALED DRAINAGE

### FEATURES

Transmittance		$U_w \geq 1,0 (W/m^2K)$
Acoustic insulation		Rw up to 45 dB
Air permeability		Class 4
Water tightness		Class E1200
Wind resistance		Class C5

Reference test 1,23 x 1,48 m / 2 sashes

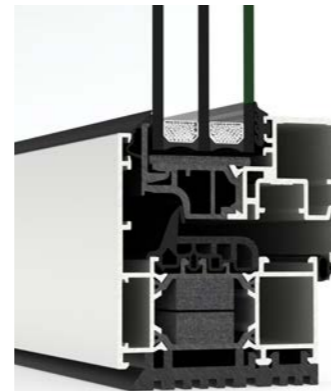

\* Possibility of concealed drainage

## COR 70 HIDDEN SASH C16 ST



# COR 3500

## C16 ST

Compatible with any standard 16 groove hardware in the market. This hinged system has a 54 mm frame depth and a thermal break zone of 24 mm. It is presented as a versatile solution for mild climates.

### POSSIBILITIES



### FEATURES

Transmittance		$U_w \geq 1,2$ (W/m <sup>2</sup> K)
Acoustic insulation		Rw up to 46 dB
Air permeability		Class 4
Water tightness		Class 9A
Wind resistance		Class C4

Reference test 1,23 x 1,48 m / 2 sashes

### OPENING POSSIBILITIES

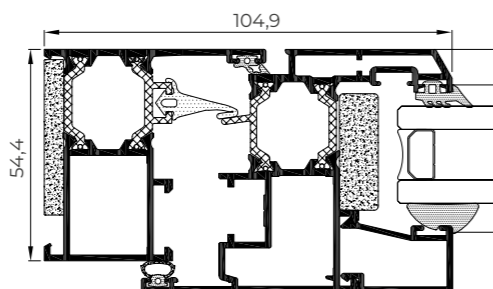
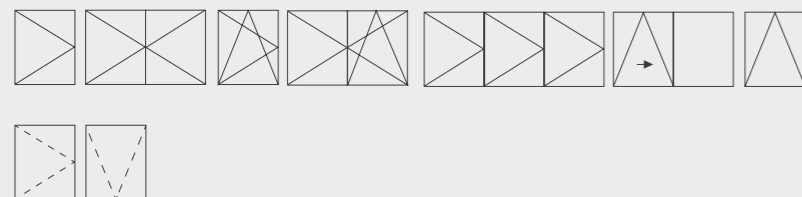

### Aesthetic possibilities:

Sash: Curved or chamfered  
Bead: Straight or curved



16 Grooven  
Thermally broken



COR 3500 C16 ST



### Sightlines

Frame 54 mm, Sash 62 mm

### Polyamide Strip Length

24 mm

### Profile Thickness

Window 1,5 mm

Door 1,7 mm

### Glazing

Max. 32 mm, Min. 27 mm

### Maximum Sash Dimensions

Width (L) 1500 mm, Height (H) 2600 mm

### Maximum Sash Weight

120 kg

Consult maximum weight and dimensions according to typologies



# COR URBAN

## C16

This system is especially suitable for buildings located in areas with high acoustic activity. This thermally broken window with double hidden sash of 122 mm, quadruple glazing and 4 gaskets, enables a noise reduction of up to 50 dB.

16 Grooven  
Thermally broken

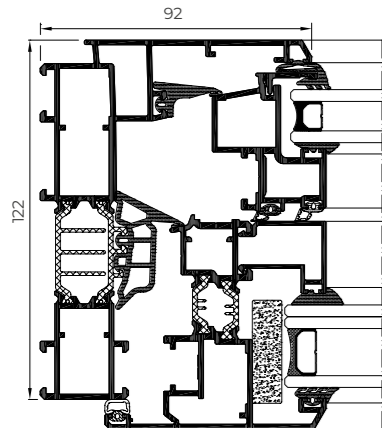

### Sightlines

Frame 122 mm, Sash 121 mm

**Polyamide Strip Length**  
Frame 35 mm, Sash 20 mm

### Profile Thickness

Window 1,6 mm

### Glazing

Internal sash: Max. 38 mm, Min. 13 mm

External sash: Max. 22 mm, Min. 11 mm

### Maximum Sash Dimensions

Width (L) 1200 mm, Height (H) 2200 mm

### Maximum Sash Weight

150 kg

Consult maximum weight and dimensions according to typologies



### Aesthetic possibilities:

Sash: Chamfered / Bead: Chamfered

### POSSIBILITIES



CONCEALED HINGES

### OPENING POSSIBILITIES

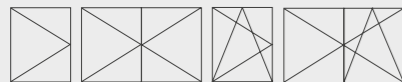

Inward opening

Side hung  
Tilt & turn

### FEATURES

Transmittance   $U_w \geq 1,2$  (W/m<sup>2</sup>K)

Acoustic insulation   $R_w$  up to 50 dB

Air permeability  Class 4

Water tightness  Class E1650

Wind resistance  Class C5

Reference test 1,23 x 1,48 m / 1 sash



COR URBAN C16

# COR GALICIA

## Premium C16

Thermally broken mixed system that combines an external aluminium profile and its excellent performance with the warmth and design that an internal timber profile provides. The extensive range of CORTIZO powder coating or anodizing finishes, any of them may be selected for the surface treatment of the external face. On the other hand, the internal face is available in American oak, sapelly, mellis pine and other timber options available on request, all of them treated with a transparent, satin, dissolvent free ecological varnish.

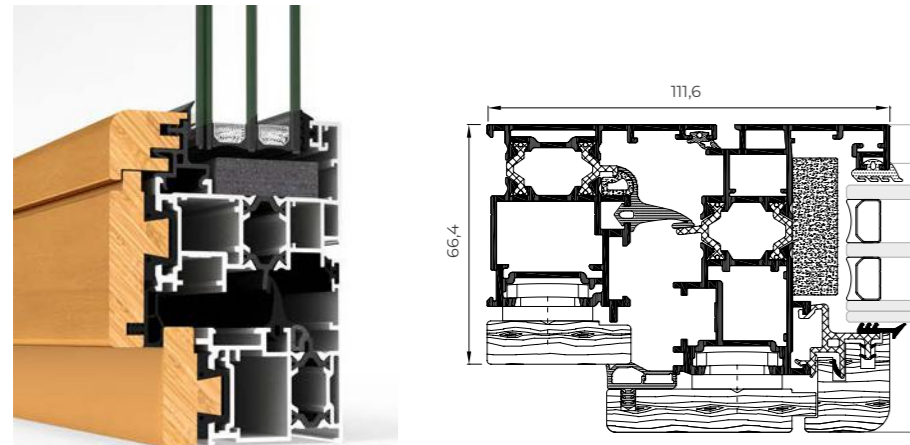

16 Grooven  
Thermally broken



### POSSIBILITIES



### FEATURES

Transmittance		$U_w \geq 1,1$ (W/m <sup>2</sup> K)
Acoustic insulation		Rw up to 40 dB
Air permeability		Class 4
Water tightness		Class E1050
Wind resistance		Class C5

Reference test 1,23 x 1,48 m / 2 sashes

### Sightlines

Frame 66,4 mm, Sash 85,3 mm

### Polyamide Strip Length

Frame 14,8 mm

Sash 16 mm

### Profile Thickness

Window 1,5 mm

Door 1,6 mm

### Glazing

Sash: Max. 40 mm, Min. 18 mm

Fixed light: Max. 30 mm, Min. 8 mm

### Maximum Sash Dimensions

Width (L) 1400 mm

Height (H) 2400 mm

### Maximum Sash Weight

100 kg

### Aesthetic possibilities:

Sash: Straight / Bead: Curved

Consult maximum weight and dimensions according to typologies

### OPENING POSSIBILITIES



Inward opening

Side hung  
Tilt & turn  
Tilt & parallel  
Bottom hung

## COR GALICIA PREMIUM C16



# COR 70

## CC16

Hinged system with a 70mm frame depth and exclusive profiles, gaskets, hardware and polyamide strips that force the fabricator to use them conjointly. Additionally, the aesthetic possibilities are expanded with curved or chamfered beads. In order to guarantee the highest quality standards in the manufacturing and installation of the window, this series can only be commercialised by members of CORTIZO's Official Fabricators Network.

Cortizo 16  
Groove  
Thermally broken

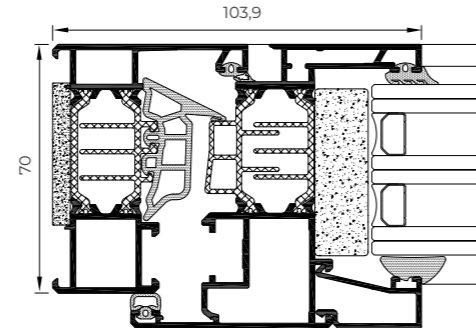

### FEATURES

Transmittance		$U_w \geq 0,8$ (W/m <sup>2</sup> K)
Acoustic insulation		Rw up to 46 dB
Air permeability		Class 4
Water tightness		Class E1500
Wind resistance		Class C5

Test reference 1,23 x 1,48 m / 2 sashes

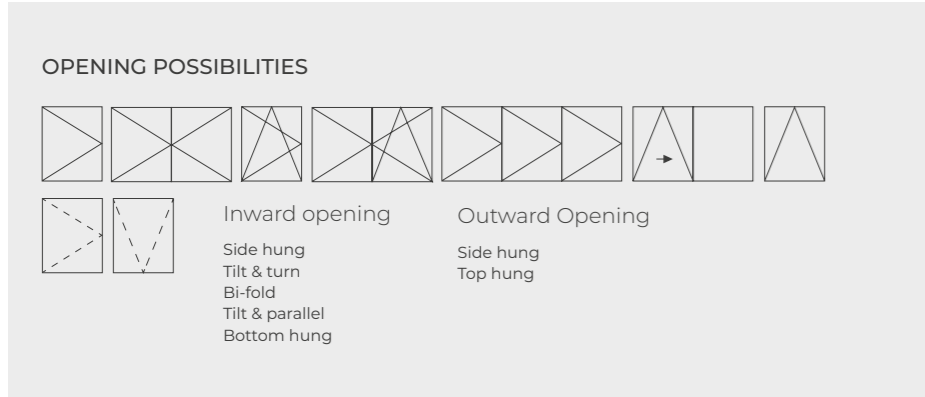

### POSSIBILITIES



**Sightlines**  
Frame 70 mm, Sash 75 / 80 mm

**Polyamide Strip Length**  
35 mm

**Profile Thickness**  
Window 1,5 mm  
Door 1,7 mm

**Glazing**  
Max. 58 mm, Min. 15 mm

**Maximum Sash Dimensions**  
Width (L) 1600 mm  
Height (H) 2800 mm

**Maximum Sash Weight**  
150 kg  
Consult maximum weight and dimensions according to typologies

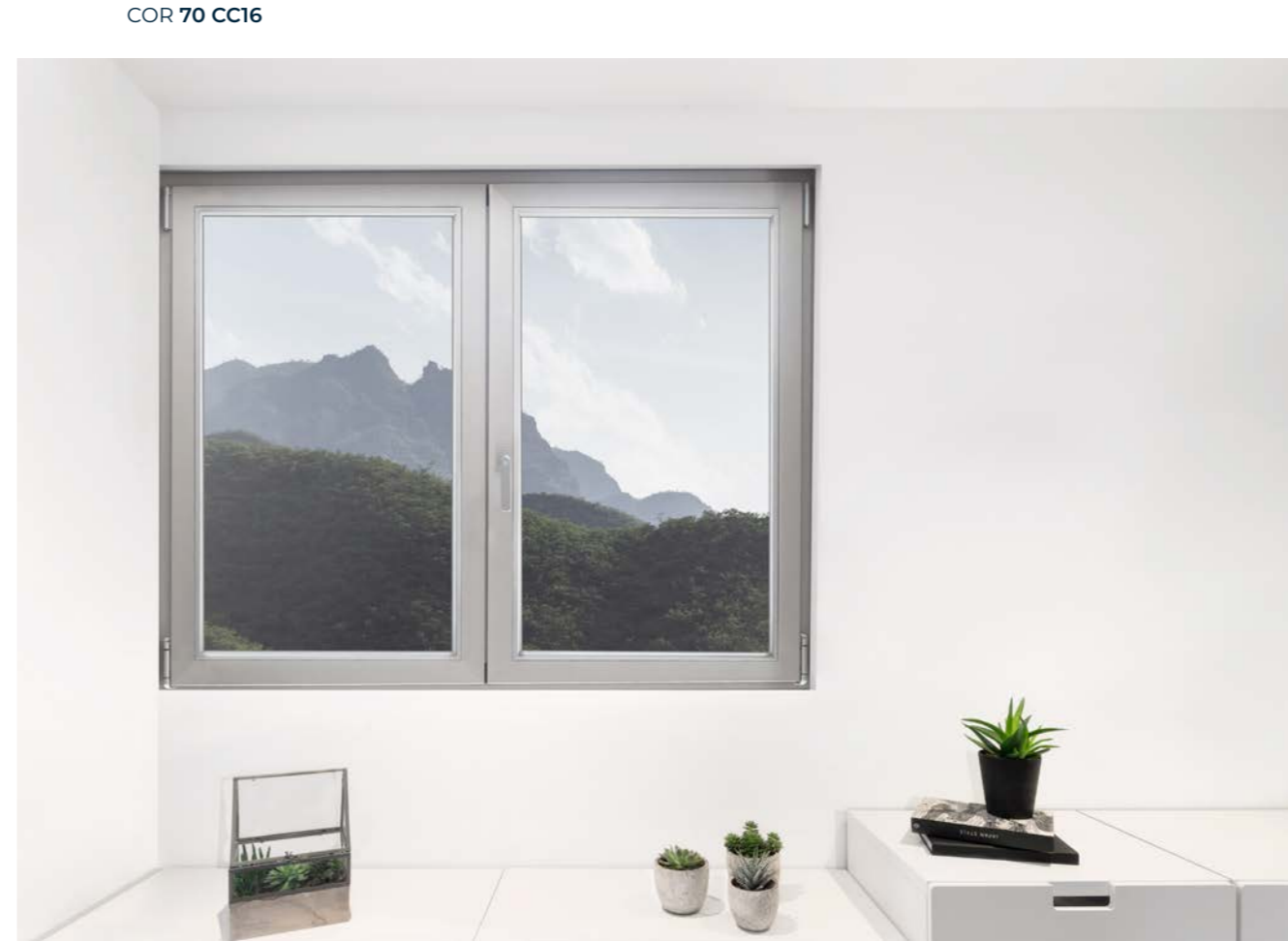

**Aesthetic possibilities:**  
Sash: Straight or chamfered  
Bead: Straight, Curved or chamfered

# COR 70

## Hidden Sash CC16

Hidden sash Cortizo 16 Groove system that combines high performance with a minimalist design. It features a frame depth and an interlock profile of 70 mm. Furthermore, as well as the visible sash version, it can only be commercialised by members of CORTIZO's Official Fabricators Network, who must manufacture it with the brand's profiles, gaskets, hardware and polyamide strips.



### Sightlines

Frame 70 mm, Sash 69 mm

### Polyamide Strip Length

Frame 35 mm, Sash 16 y 20 mm

### Profile Thickness

Window 1,5 mm

### Glazing

Max. 35 mm, Min. 22 mm

### Maximum Sash Dimensions

Width (L) 1600 mm, Height (H) 2800 mm

### Maximum Sash Weight

150 kg

Consult maximum weight and dimensions according to typologies

### FEATURES

Transmittance		$U_w \geq 1,3$ (W/m <sup>2</sup> K)
Acoustic insulation		Rw up to 45 dB
Air permeability		Class 4
Water tightness		Class E1500
Wind resistance		Class C5

Reference test 1,30 x 1,55 m / 1 sash

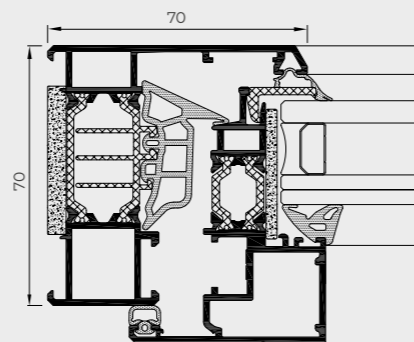

### POSSIBILITIES



CONCEALED HINGES

### OPENING POSSIBILITIES



Inward opening

Side hung  
Tilt & turn  
Tilt & parallel  
Bottom hung

Cortizo 16  
Groove

Thermally broken



# COR 60

## CC16

Hinged system with 60 mm of frame depth that combines remarkable thermal and acoustic performance with the advantages of the Cortizo 16 Groove: Larger gasket contact, better adjustment and aesthetics with a 45° or 90° glazing bead.

### FEATURES

Transmittance		$U_w \geq 0,9$ (W/m <sup>2</sup> K)
Acoustic insulation		Rw up to 46 dB
Air permeability		Class 4
Water tightness		Class E1200
Wind resistance		Class C5

Reference test 1,31 x 1,48 m / 2 sashes

### POSSIBILITIES



CONCEALED HINGES



ACCESSIBILITY

### OPENING POSSIBILITIES

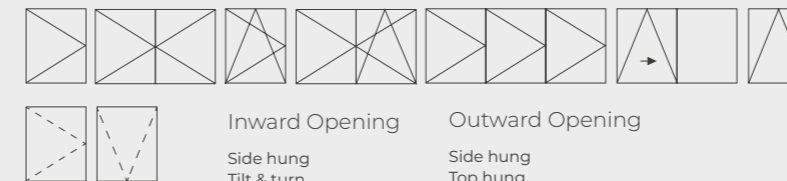

Inward Opening

Side hung  
Tilt & turn  
Bi-fold  
Tilt & parallel  
Bottom hung

Outward Opening

Side hung  
Top hung

Cortizo 16  
Groove

Thermally broken

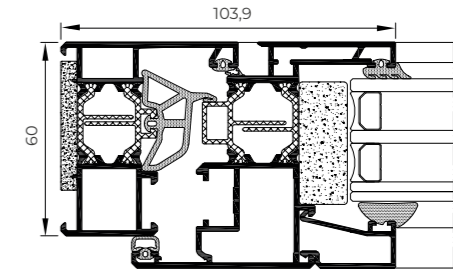

### Sightlines

Frame 60 mm, Sash 65 / 70 mm

### Polyamide Strip Length

25 mm

### Profile Thickness

Window 1,5 mm

Door 1,7 mm

### Glazing

Max. 48 mm, Min. 5 mm

### Maximum Sash Dimensions

Width (L) 1600 mm, Height (H) 2800 mm

### Maximum Sash Weight

150 kg

### Aesthetic possibilities:

Sash: Straight or chamfered

Bead: Straight, curved or chamfered



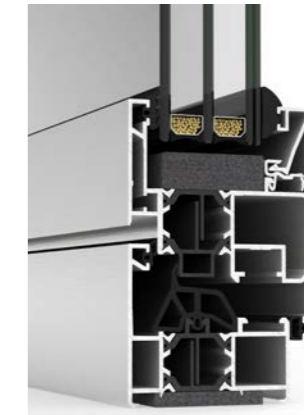



Consult maximum weight and dimensions according to typologies



# CASEMENT

Thermally broken window that allows for both side hung and top hung outward openings. This solution, with a thermal break zone of 32 mm and a transmittance  $U_w$  from 1,0 W/m<sup>2</sup>K, has the British security certification PAS 24, being especially suitable for this market.

## FEATURES

Transmittance		$U_w \geq 1,0$ (W/m <sup>2</sup> K)
Acoustic insulation		Rw up to 45 dB
Air permeability		Class 4
Water tightness		Class E1200
Wind resistance		Class CE 2400
Security test	 	PASSED

Reference test 1,438 x 1,355 m / 1 sash + 1 fixed light  
Security test: Reference test 1,438 x 1,355 m / 1 sash + 1 fixed light

## POSSIBILITIES



SECURITY  
HARDWARE



CONCEALED  
HINGES

## OPENING POSSIBILITIES



Outward Opening

Side hung  
Top hung

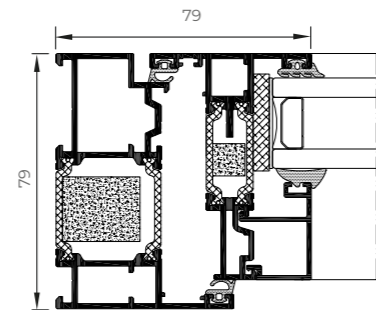

\* Flush Version

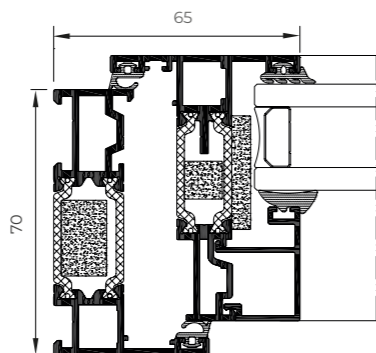

\* Standard Version



Thermally broken

## Sightlines

Frame 70 mm, Sash 70 mm

## Polyamide Strip Length

32 mm

## Profile Thickness

Window 1,6 mm

## Glazing

Max. 44 mm, Min. 23 mm

## Maximum Sash Dimensions

### Slim Sash (Side Hung):

Width (L) 700 mm, Height (H) 1300 mm

### Slim Sash (Top Hung):

Width (L) 1200 mm, Height (H) 1300 mm

### Heavy Duty Sash (Side Hung):

Width (L) 750 mm, Height (H) 1750 mm

### Heavy Duty Sash (Top Hung):

Width (L) 1800 mm, Height (H) 1800 mm

## Maximum Sash Weight

Side Hung Slim Sash: 35 kg

Top Hung Slim Sash: 50 kg

Side Hung Heavy Duty Sash: 42 kg

Top Hung Heavy Duty Sash: 100 kg

Consult maximum weight and dimensions according to typologies



CASEMENT

contemporary  
enclosures



**door** systems

## Millennium Plus 80

### DOOR

Flush entrance door system with straight lines, 80 mm of frame depth, and a thermal break zone of 34 mm, particularly suitable for commercial and residential buildings.

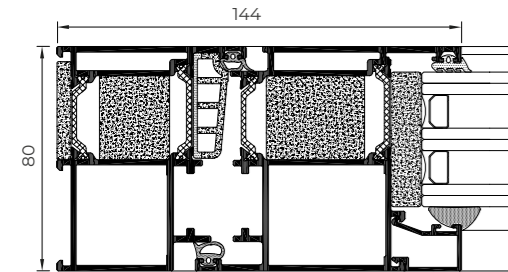

#### FEATURES

Transmittance		$U_w \geq 0,8$ (W/m <sup>2</sup> K)
Acoustic insulation		Rw up to 40 dB
Air permeability		Class 4
Water tightness		Class 6A
Wind resistance		Class C4
Resistance to mild impact		Class 5 (Max.)
Repeated openings and closings		1.000.000 Cycles

Wind resistance: Reference test 1,20 x 2,30 m / 1 sash  
 Resistance to mild impact: EN 13049. Test on door reference 1,80 x 2,20 m / 2 sashes. Laminated glass 3+3  
 Resistance to repeated openings and closings: EN 1191. Test on door reference 0,935 x 2,10 m / 1 sash

#### Sightlines

Frame 80 mm, Sash 80 mm

#### Polyamide Strip Length

34 mm

#### Profile Thickness

Door 2,0 mm

#### Glazing

Max. 64 mm, Min. 15 mm

#### Maximum Sash Dimensions

Door:

Width (L) 1800 mm, Height (H) 3000 mm

Concealed door hinges:

Width (L) 1500 mm, Height (H) 2700 mm

#### Maximum Sash Weight

220 kg / 120 Kg (concealed hinges)

Consult maximum weight and dimensions according to typologies



#### POSSIBILITIES



CONCEALED HINGES



ACCESSIBILITY



AUTOMATION

#### OPENING POSSIBILITIES

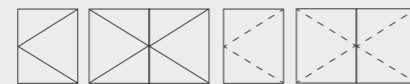

Inward Opening

Side hung

Outward opening

Side hung

Automatic Opening

Inward and outward side hung

## Millennium Plus 70

### DOOR

Flush entrance pedestrian door system with 70 mm of frame depth that guarantees high thermal and acoustic insulation.

#### Sightlines

Frame 70 mm, Sash 70 mm

#### Polyamide Strip Length

24 mm

#### Profile Thickness

Door 2,0 mm

#### Glazing

Max. 54 mm, Min. 15 mm

#### Maximum Sash Dimensions

Door:

Width (L) 1800 mm, Height (H) 3000 mm

Concealed door hinges:

Width (L) 1500 mm, Height (H) 2700 mm

#### Maximum Sash Weight

220 kg

120 Kg (concealed hinges)

Consult maximum weight and dimensions according to typologies



#### OPENING POSSIBILITIES



Inward Opening

Side hung

Outward opening

Side hung

Automatic Opening

Outward and inward side hung

Swing Opening

Side hung

#### FEATURES

Transmittance		$U_w \geq 0,9$ (W/m <sup>2</sup> K)
Acoustic insulation		Rw up to 38 dB
Air permeability		Class 4
Water tightness		Class 6A
Wind resistance		Class C4
Resistance to mild impact		Class 5 (Max.)
Repeated opening and closings		1.000.000 cycles

Wind resistance: Reference test 1,20 x 2,30 m / 1 sash  
 Resistance to mild impact: EN 13049. Test on door reference 1,80 x 2,20 m / 2 sashes. Laminated glass 3+3  
 Resistance to repeated openings and closings: EN 1191. Test on door reference 2,1 x 2,2 m / 2 sashes

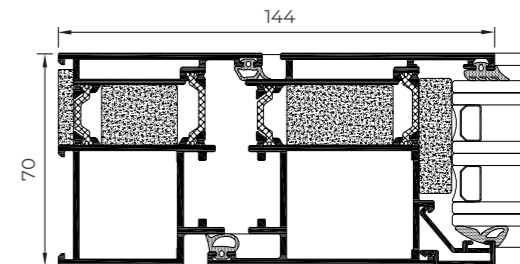

#### POSSIBILITIES



CONCEALED HINGES



ACCESSIBILITY



AUTOMATION



MILLENNIUM PLUS 80 DOOR

## CONCEALED HINGES

The Millennium Plus door system allows **concealed hinges** that reinforce the flush aesthetic of the series





## Millennium Plus Pivot DOOR

This new entrance door from Cortizo answers the latest design trends. The system is designed to allow large pivot openings suitable for contemporary architectural projects, and it offers excellent thermal and acoustic performance along with minimalistic sightlines.

### Sightlines

Frame 80 mm, Sash 80 mm

### Polyamide Strip Length

24 / 26 mm

### Profile Thickness

Door 2,0 mm

### Panel

80 mm

### Maximum Sash Dimensions

Width (L) 2100 (1700\* + 400 mm)

Height (H) 3000 mm

### Maximum Sash Weight

250 kg

Consult maximum weight and dimensions according to typologies  
\* Measure from the pivot axis

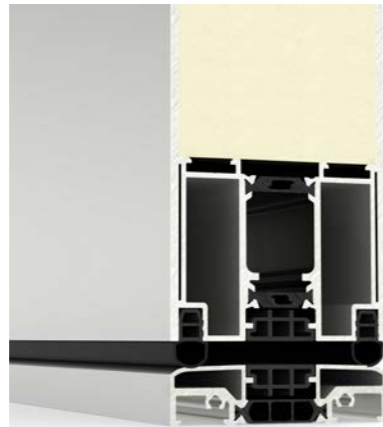

### FEATURES

Transmittance		$U_D \geq 0.79$ (W/m <sup>2</sup> K)
Air permeability		Class 4
Water tightness		Class 5A
Wind resistance		Class C5

Reference test 1,20 x 2,00 m / 1 Sash

### POSSIBILITIES

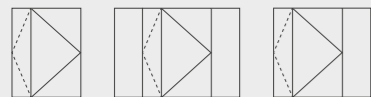

Pivoting

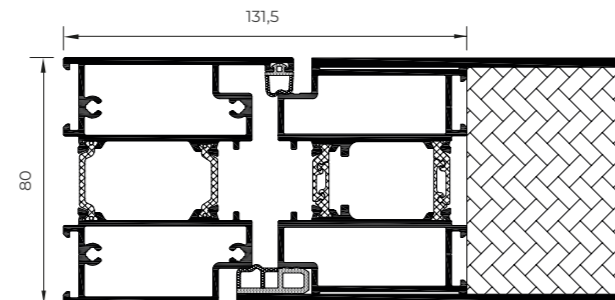

Doors

## MILLENNIUM PLUS PIVOT DOOR



## Panelled DOOR

Compatible with the Millennium Plus 80 and Millennium Plus 70 series, it incorporates a panel integrated into the sash, which allows a wide range of aesthetic possibilities. In addition, it allows for the installation of an embedded handle with led illumination and a scanner.

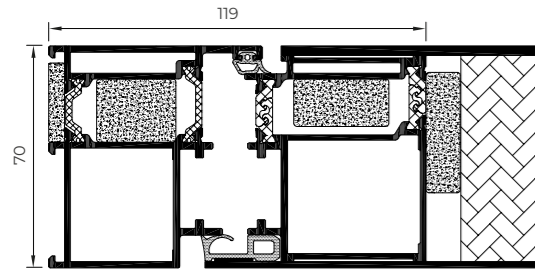

### OPENING POSSIBILITIES

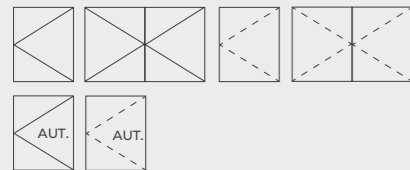

Inward Opening

Side hung

Automatic side hung

Outward Opening

Side hung

Automatic side hung

Wind resistance: Reference test 1,20 x 2,30 m / 1 sash  
Resistance to mild impact: Test carried out according to standard EN 13049  
Test on door reference 1,80 x 2,20 m / 2 sashes. Laminated glass 3+3  
Resistance to repeated openings and closing: Test carried out according to standard EN 1191  
Test on door reference 0,935 x 2,10 m / 1 sash

\*Compatible with Millennium Plus 70 and 80 doors

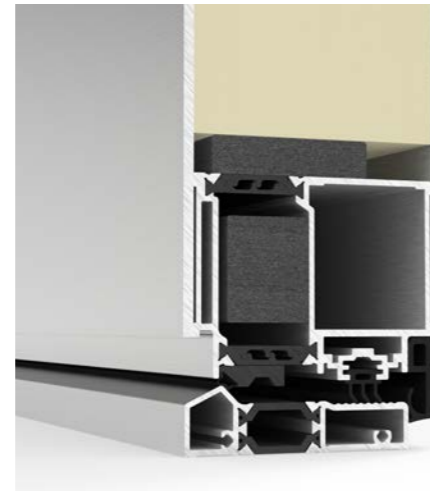

### Sightlines

Frame 80 / 70 mm, Sash 80 / 70 mm

### Polyamide Strip Length

30 / 34 mm (80)

20 / 24 mm (70)

### Profile Thickness

Door 2,0 mm

### Panel

Max. 80 mm, Min. 33 mm (80)

Max. 70 mm, Min. 23 mm (70)

### Maximum Sash Dimensions

#### Door:

Width (L) 1800 mm, Height (H) 3000 mm

Concealed door hinges:

Width (L) 1500 mm, Height (H) 2700 mm

#### Maximum Sash Weight

220 kg

120 Kg (concealed hinges)

Consult maximum weight and dimensions according to typologies

Doors



## Millennium FR

### DOOR

Aluminium fire door system with fire resistance category EI260 in order to meet safety requirements in the event of fire, allowing the compartmentalisation by building areas and facilitating the evacuation of the users. It offers a fire resistance period of 60 minutes thanks to the use of non-combustible retardant insulation materials in the profile chambers and intumescent gaskets.

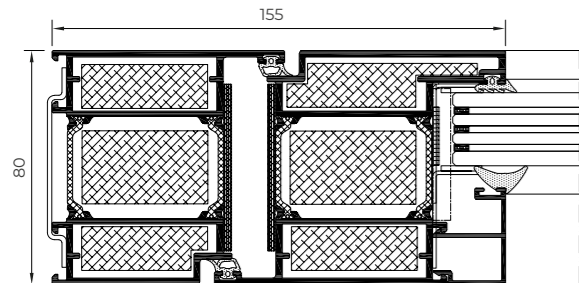

#### FEATURES

Transmittance		$U_w \geq 1,4$ (W/m <sup>2</sup> K)
Acoustic insulation		Rw up to 38 dB
Fire resistance and smoke control		Class EI <sub>2</sub> 60-C5

Classification according to standard UNE-EN 13501-2+A1 (C5=200.000 test cycles)  
Reference test 1,35 x 2,35 m / 1 sash. Class EI60 single glazed 23 to 25 mm.



#### Sightlines

Frame 80 mm, Sash 80 mm

#### Polyamide Strip Length

35 mm

#### Profile Thickness

Door 2,2 mm

#### Glazing

Max. 48 mm, Min. 15 mm

#### Maximum Sash Dimensions

Width (L) 1450 mm, Height (H) 2600 mm

#### Maximum Sash Weight

240 kg

Consult maximum weight and dimensions according to typologies

#### OPENING POSSIBILITIES

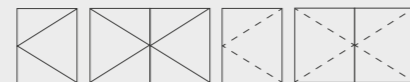

Inward opening  
Side hung  
Outward Opening  
Side hung

Doors

## Millennium 2000

### DOOR

Pedestrian door system for commercial and residential buildings that allows the incorporation of double or triple flag hinges of high strength, capable of supporting up to 180 kg. per sash.

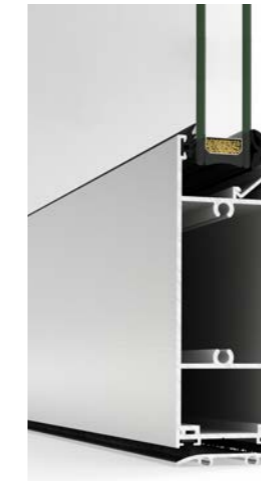

#### Sightlines

Frame 45 mm, Sash 45 mm

#### Profile Thickness

Door 2,0 mm

#### Glazing

Max. 30 mm, Min. 3 mm

#### Maximum Sash Dimensions

Side hung:

Width (L) 1450 mm, Height (H) 3000 mm

Swing:

Width (L) 1100 mm, Height (H) 3000 mm

#### Maximum Sash Weight

180 kg

Consult maximum weight and dimensions according to typologies

#### OPENING POSSIBILITIES

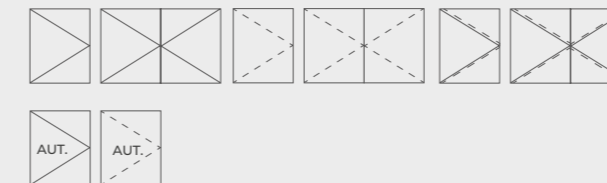

Inward opening  
Side hung  
Automatic side hung

Outward Opening  
Side hung  
Automatic side hung

Swing Opening  
Side hung 1 and 2 sashes

Doors

#### POSSIBILITIES



ACCESSIBILITY

#### Aesthetic possibilities:

Sash: Straight / Bead: Straight or curved

#### FEATURES

Transmittance		$U_w \geq 2,3$ (W/m <sup>2</sup> K)
Acoustic insulation		Rw up to 38 dB
Resistance to mild impact		Class 5 (Max.)

Test carried out according to standard UNE-EN 13059  
Reference test 1,80 x 2,20 m / 2 sashes. Laminated glass 3+3

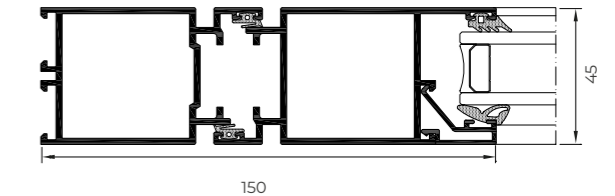



MILLENNIUM SLIDING AUTOMATIC DOOR

## Millennium Sliding Automatic

### DOOR

Door system with sliding sashes and automatic opening, designed to solve high traffic entrances (offices, shopping centres, hospitals...) since it guarantees fluidity of user's traffic and safety in emergency situations.

#### POSSIBILITIES



AUTOMATION



ACCESSIBILITY



#### Sightlines

Frame 45 mm

Sash 45 mm (EC-drive engine)

Sash 25 mm (Slimdrive engine)

#### Profile Thickness

Door 2,0 mm

#### Glazing

Max. 30 mm, Min. 3 mm

#### Maximum Sash Dimensions

Width (L) 2000 mm, Height (H) 3000 mm

#### Maximum Sash Weight

120 Kg

Consult maximum weight and dimensions according to typologies

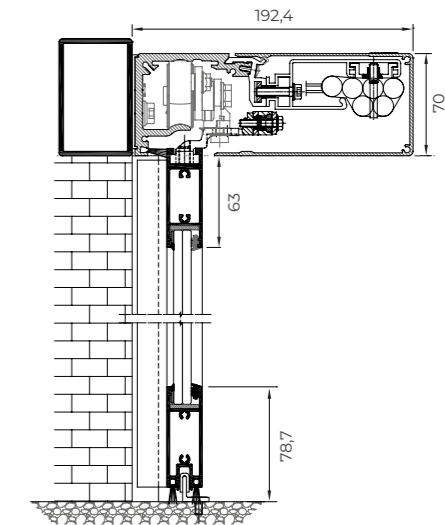

#### OPENING POSSIBILITIES



Automatic Opening  
 Sliding 1 sash and 1 fixed light  
 Sliding 2 sashes and 2 fixed lights



# BI - FOLD

Thermally broken system with 73 mm of frame depth, ideal to divide environments and unify spaces both in residential and commercial buildings. It allows multiple combinations of up to 14 sashes that allow to close spans of more than 16 meters wide. It has slim sightlines and hidden rollers, showing a clean aesthetic in the closed position. In addition, the flush threshold facilitates accessibility and transit between the interior and exterior.

## FEATURES

Transmittance		$U_w \geq 1,1$ (W/m <sup>2</sup> K)
Air permeability		Class 4
Water tightness		Class 9A
Wind resistance		Class A3
Security test		PAS24 PASSED

Wind resistance: reference test 2,700 x 2,530 m / 3 sashes  
 Security test: Configuration 330. 2701 x 2517 mm / 3 sashes

## OPENING POSSIBILITIES

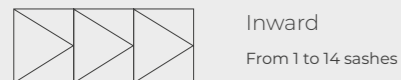

Outward  
From 1 to 14 sashes  
Possibility of corner sash at 90° without mullion

## POSSIBILITIES

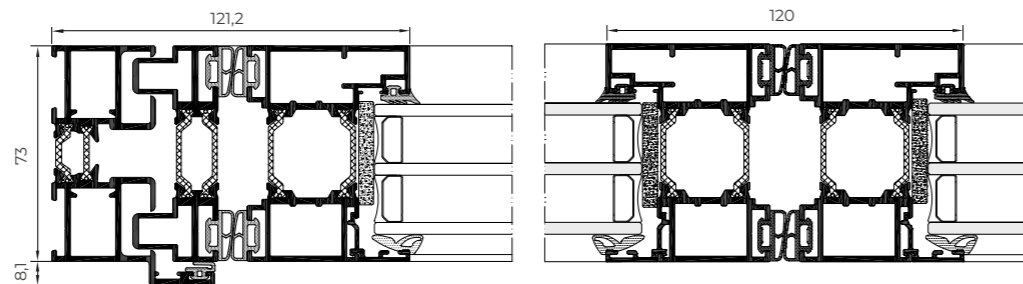

## Sightlines

Frame 73 mm, Sash 73 mm

## Polyamide Strip Length

Frame 20 mm

Sash 30 mm

## Profile Thickness

Door 1,8 mm

## Glazing

Max. 45 mm, Min. 25 mm

## Maximum Sash Dimensions

Width (L) 1200 mm, Height (H) 3000 mm

## Maximum Sash Weight

120 kg

Consult maximum weight and dimensions according to typologies



BI - FOLD

contemporary  
enclosures







**sliding** window and door systems

# COR VISION

## Plus

The greatness of minimalism is reflected in this sliding system of large dimensions with sashes of up to 4 meters, interlock sightline of only 25 mm and frames embedded in the perimeter, allowing for a glazed surface of up to 94%. It has a maximum glazing capacity of 54 mm, offering excellent thermal and acoustic performances. Available with manual (up to 400 kg) or motorized (up to 700 kg) opening system. Additionally, accessibility is favoured by the possibility of hiding the rail and even integrating it fully into the floor.

### FEATURES

Transmittance		$U_w \geq 0,9$ (W/m <sup>2</sup> K)
Acoustic insulation		Rw up to 43 dB
Air permeability		Class 4
Water tightness		Class 7A* / 9A**
Wind resistance		Class C3* / C4**

Wind resistance:  
 \* Reference test balcony 4,00 x 3,00 m / 2 sashes  
 \*\* Reference test balcony 4,00 x 3,00 m / 1 sash + 1 fixed light

### OPENING POSSIBILITIES

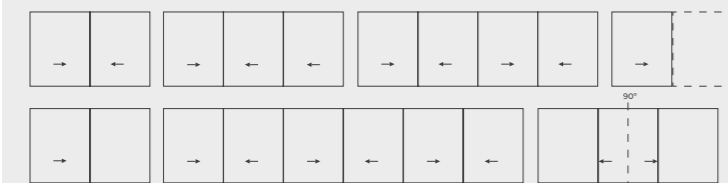

Sliding  
 Possibility of 1, 2, 3 or 4 rails  
 Possibility of interior and exterior corner sash at 90° without mullion  
 Pocket possibility

Sliding  
 Thermally broken

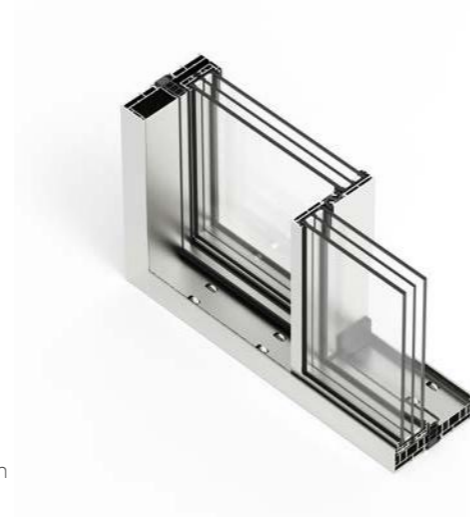

### Sightlines

Frame 180 mm / 278 mm 3 rails

Sash 69 mm

### Polyamide Strip Length

Frame 40 mm

Sash 18 / 32 mm

### Profile Thickness

Door 2,0 mm

### Glazing

Max. 56 mm, Min. 36 mm

### Maximum Sash Dimensions

Width (L) 4000 mm, Height (H) 4000 mm

\*Glazed surface 14 m<sup>2</sup>

### Maximum Sash Weight

400 kg Manual

700 Kg Motorized

Consult maximum weight and dimensions according to typologies

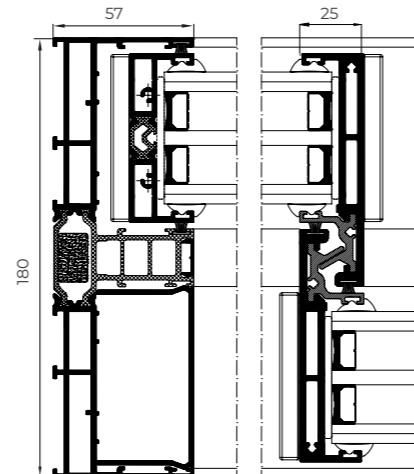

## COR VISION PLUS





**DRAINAGE SOLUTION**

**HIDDEN TRACK SOLUTION**

Possibility of **embedding the bottom profile and integrate it within the floor finish** (pallet, pavement, ceramic...), achieving a transition without any obstacle between the interior and exterior of the room.



**SECURITY HARDWARE**

**FLUSH SECURITY HARDWARE**

**MAXIMUM SECURITY**

Locking system with internal and external key.  
 Embedding of the hardware into the profile with the same minimalist aesthetic.  
 Possibility of powder coating in any color to provide uniformity to the ensemble.

**POSSIBILITIES**



AUTOMATION



ACCESSIBILITY



**HIDDEN SASH**  
 Allows the concealment of the sashes in the lateral corners

**INTERLOCK PROFILE**  
 Only 25 mm

Option of **INTERLOCK HANDLE**

**MAX. GLAZING**  
 Up to 56 mm

**LARGE DIMENSIONS**  
 Up to 4000 mm of height or width / sash

**UP TO 700 KG / Motorized**  
**UP TO 400 KG / Manual**

**COR VISION PLUS**



# COR VISION

Thermally broken minimalist sliding system that provides maximum luminosity with a minimal aluminium interlock profile. It has an elegant design only 20 mm sightline and offers the possibility of an inlaid closing system and of hiding the frame along the perimeter. Possibility of locking system in the interlock, thus allowing the concealment of the sashes in the frame from a frontal view.

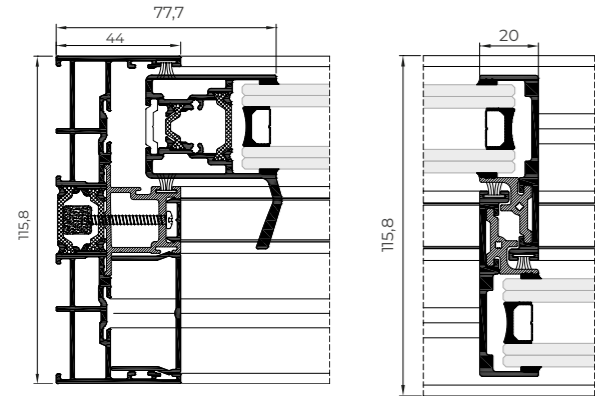

### Sightlines

Frame 116 mm / 182 mm 3 rails

Sash 37 mm

### Polyamide Strip Length

16 / 24 mm

### Profile Thickness

Door 1,7 mm

### Glazing

Max. 30 mm, Min. 26 mm

### Maximum Sash Dimensions

Width (L) 2500 mm, Height (H) 3000 mm

### Maximum Sash Weight

320 Kg

Consult maximum weight and dimensions according to typologies

### FEATURES

Transmittance		$U_w \geq 1,3 (W/m^2K)$
Acoustic insulation		Rw up to 41 dB
Air permeability		Class 4
Water tightness		Class 7A
Wind resistance		Class C5

Reference test 1,23 x 1,55 m / 1 sash + 1 fixed light

### POSSIBILITIES



### OPENING POSSIBILITIES

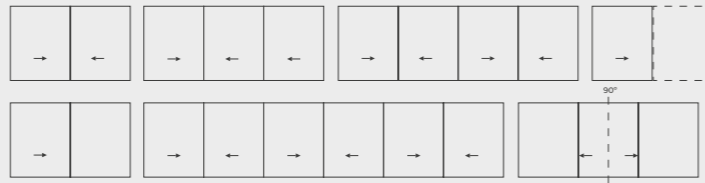

Sliding  
Possibility of 1, 2 or 3 rails  
Possibility of interior and exterior corner at 90° without mullion  
Pocket possibility

Sliding

Thermally broken



## COR VISION



# 4600 HI

## Lift & Slide

Ideal solution to close large spans, offering excellent thermal ( $U_w$  from 0.9  $W/m^2K$ ) and acoustic ( $R_w$  up to 43 dB) performance along with a modern design with straight aesthetics in the sashes and beads. It includes a hardware system that slightly elevates the sash when the handle is operated, facilitating its movement in the opening and closing motions, even in the case of sashes with large dimensions and weight. Possibility of a reduced interlock sightline of 50 mm.

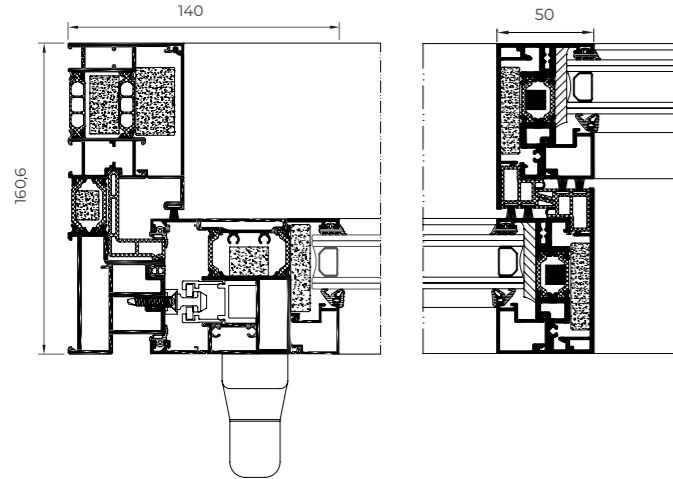

### FEATURES

Transmittance		$U_w \geq 0,9 (W/m^2K)$
Acoustic insulation		$R_w$ hasta 43 dB
Air permeability		Class 4
Water tightness		Class 9A
Wind resistance		Class C5

Reference test 4,0 x 2,4 m / 2 sashes

Sliding

Thermally broken

### POSSIBILITIES



ACCESSIBILITY

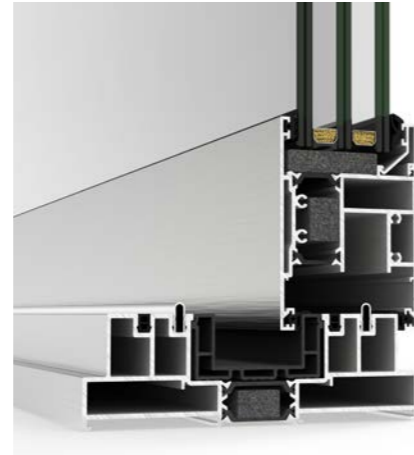

#### Sightlines

Frame 160,6 mm / 251 mm 3 rails,  
Sash 70 mm

#### Polyamide Strip Length

Frame 35 mm  
Sash 24 mm

#### Profile Thickness

Door 2,0 mm

#### Glazing

Max. 55 mm, Min. 15 mm

#### Maximum Sash Dimensions

Width (L) 3300 mm, Height (H) 3300 mm

#### Maximum Sash Weight

400 kg

Consult maximum weight and dimensions according to typologies

### OPENING POSSIBILITIES

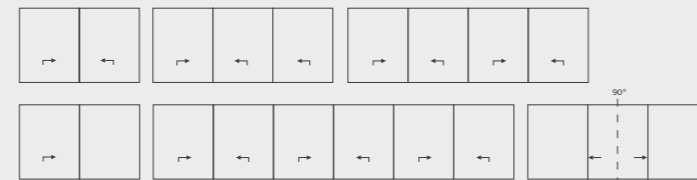

Lift & Slide

1 rail (sash + fixed light), 2 and 3 rails

Possibility of 90° opening without mullion

# 4500

## Lift & Slide / Standard Slide

This high-performance sliding system with straight or curved aesthetic is designed with a lift & slide or standard slide opening system, allowing the closing of great spans with arrangements of 6 sashes.

### FEATURES

Transmittance		$U_w \geq 1,5 (W/m^2K)$
Acoustic insulation		$R_w$ up to 42 dB
Air permeability		Class 4*
Water tightness		Class 8A*
Wind resistance		Class C4**

\* Reference test 2,62 x 2,5 m / 2 sashes (window)  
\*\* Reference test 1,85 x 2,05 m / 1 sash + 1 fixed light

### OPENING POSSIBILITIES

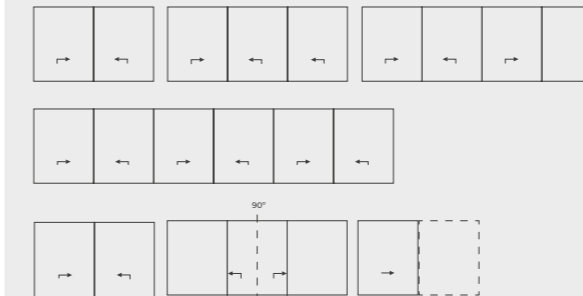

Sliding

1 rail (sash + fixed light), 2 and 3 rails

Possibility of corner sash encounters at 90°

without mullions

Pocket possibility

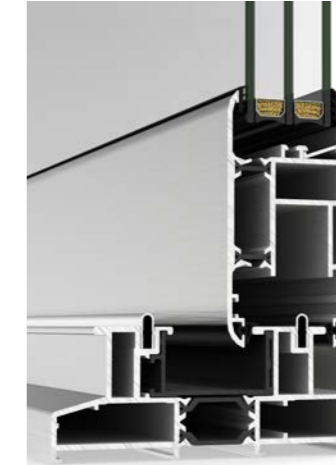

#### Sightlines

Frame 100 / 123 / 127 mm  
3 rails 185 mm

Sash 51 mm

#### Polyamide Strip Length

Lift & Slide

Frame 24 mm

Sash 14,6 mm

Standard Slide

Frame 30 mm

Sash 14,6 mm

#### Profile Thickness

Door 2,0 mm

#### Glazing

Max. 38 mm, Min. 4 mm

#### Maximum Sash Dimensions

Lift & Slide

Width (L) 3300 mm

Height (H) 3300 mm

Standard Slide

Width (L) 2500 mm

Height (H) 2600 mm

#### Maximum Sash Weight

Lift & Slide 400 kg

Standard Slide 280 Kg

#### Aesthetic possibilities:

Sash: Curved or chamfered

Bead: Straight, curved or chamfered

Consult maximum weight and dimensions according to typologies

Sliding

Thermally broken

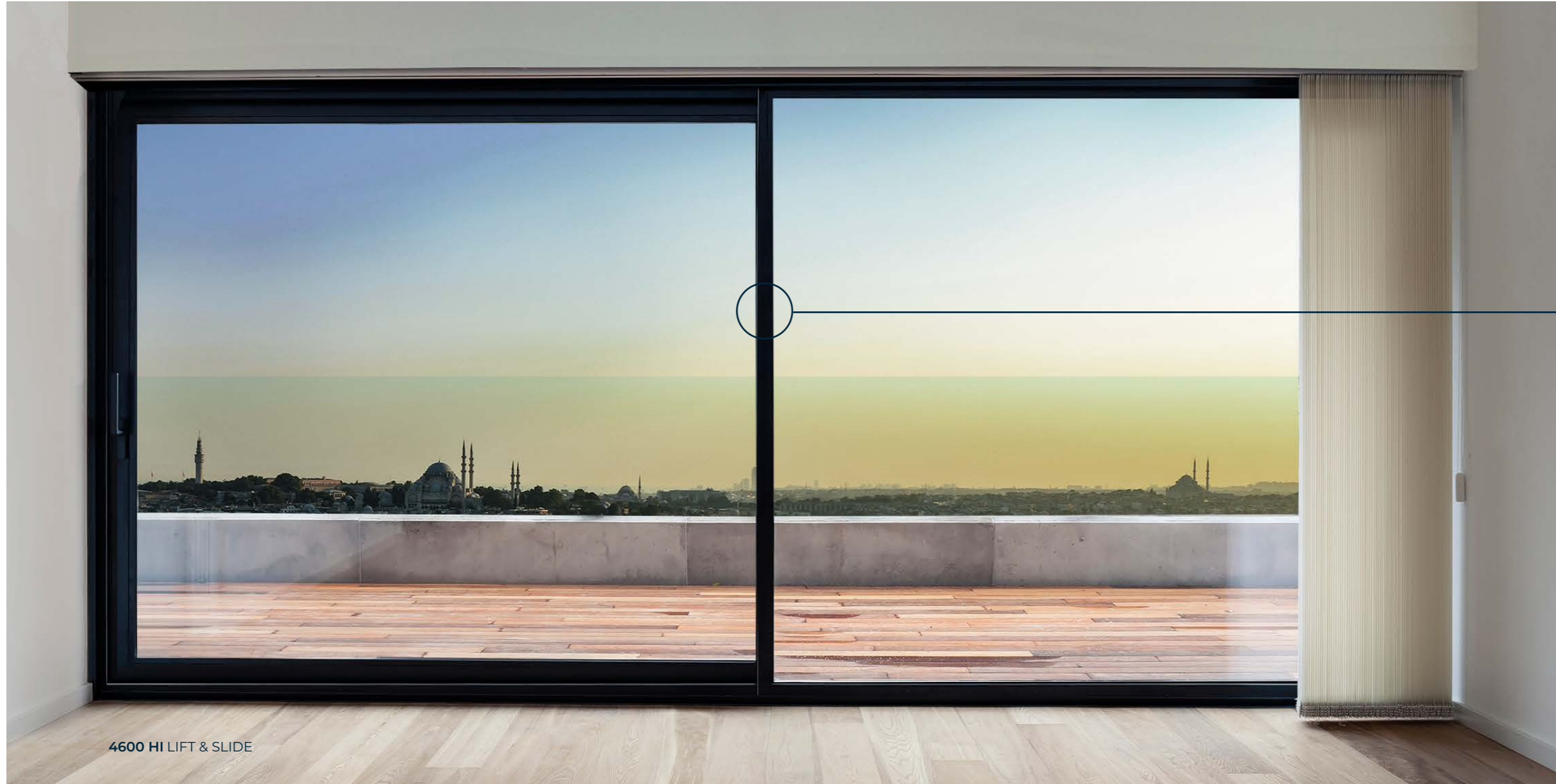

4600 HI LIFT & SLIDE

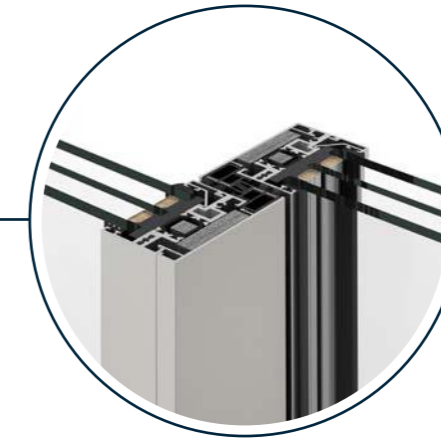

### SLIM INTERLOCK

Possibility of a **reduced interlock section of 50 mm** in monorail frame (sash + fixed light) and 2 rail frame, allowing a larger glazed surface.

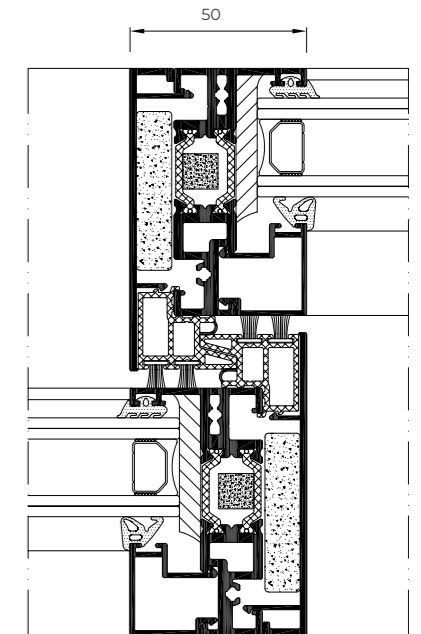

4700

Sliding

Standard sliding system with straight aesthetic and a reduced interlock section of 47 mm, ideal for closing large spans without using a lift & slide solution, it combines great thermal and acoustic performance with large glazed surfaces of up to 88%.

Sliding  
Thermally broken

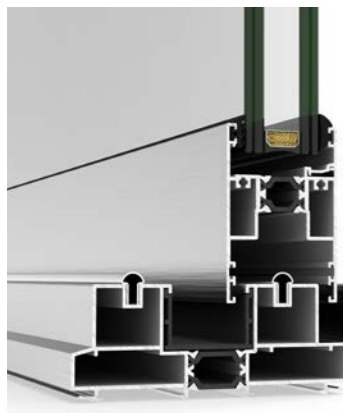

FEATURES

Transmittance		$U_w \geq 1,1 (W/m^2K)$
Acoustic insulation		Rw up to 40 dB
Air permeability		Class 3
Water tightness		Class 7A
Wind resistance		Class C5
Security test		PASSED

Reference Test AEV 1,8 x 2,2 m / 2 Sashes

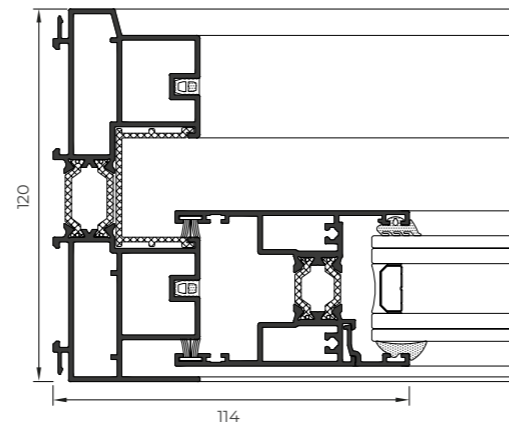

Sightlines

Frame 115 and 120 mm, 185 mm 3 rails

Sash 50 mm

Polyamide Strip Length

20-25 mm

Profile Thickness

Balcony 1,5 mm

Glazing

Max. 34 mm, Min. 26 mm

Maximum Sash Dimensions

Width (L) 2500 mm, Height (H) 3000 mm

Maximum Sash Weight

280 Kg

Consult maximum weight and dimensions according to typologies

OPENING POSSIBILITIES



Sliding  
1 rail (sash + fixed light)  
2 and 3 rails  
Pocket possibility

POSSIBILITIES



ACCESSIBILITY



4700 CORREDERA

# 4900 HI

## Sliding

Standard sliding system with hinged features. Offers great thermal and acoustic performance favoured by a glazing capacity of up to 36 mm and a thermal break zone of 34 mm. It has a interlock section of 35 mm and straight lines, allowing the sashes to cross over thanks to the integrated handle with multilock system.

Sliding  
Thermally broken



### POSSIBILITIES



ACCESSIBILITY

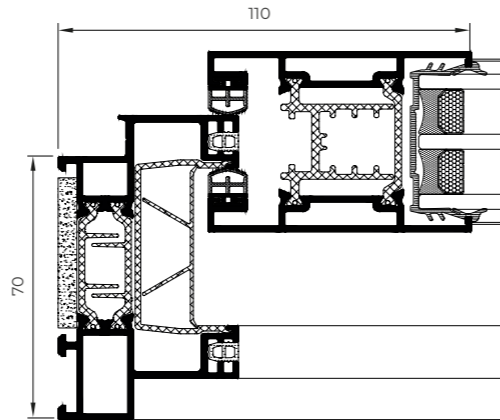

### OPENING POSSIBILITIES



Sliding  
1 rail (sash + fixed light)  
2 and 3 rails  
Pocket possibility

### FEATURES

Transmittance		$U_w \geq 1,2 (W/m^2K)$
Acoustic insulation		Rw up to 40 dB
Air permeability		Class 4
Water tightness		Class 7A
Wind resistance		Class C5

Reference test 1,80 x 2,20 m / 2 sashes  
CSTB Laboratory DTA Certification

**Sightlines**  
Frame 60, 70, 89, 120, 125, 130 mm  
126, 145 mm 3 rails  
201 mm 4 rails  
Sash 48 mm

**Polyamide Strip Length**  
34 mm

**Profile Thickness**  
Window 1,6 mm

**Glazing**  
Max. 36 mm, Min. 24 mm

**Maximum Sash Dimensions**  
Width (L) 2200 mm, Height (H) 2600 mm

**Maximum Sash Weight**  
240 kg

Consult maximum weight and dimensions according to typologies



4900 HI SLIDING

# 4200

## Sliding

Standard sliding system with great versatility and straight or curved aesthetics, 45° or 90° sash encounters and various frames according to each configuration. The 45° and 90° sash encounter version permits the total opening of the span with the pocket possibility solution, completely concealing the sashes in the masonry wall's chamber. Furthermore, this version allows the integration of the solar protection Tamiz system on the same frame.

Sliding  
Thermally broken



### FEATURES

Transmittance		Uw ≥ 1,5 (W/m²K)
Acoustic insulation		Rw up to 39 dB
Air permeability		Class 3
Water tightness		Class 7A
Wind resistance		Class C5

Reference test 1,20 x 1,20 m / 2 sashes

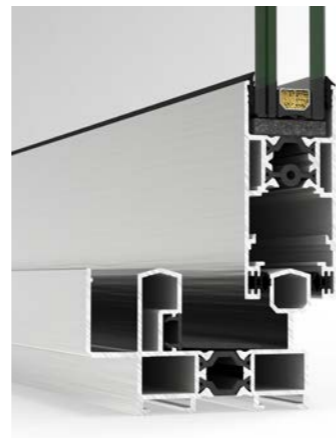
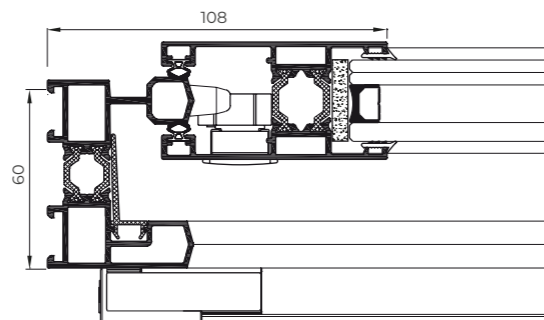

**Sightlines**  
Frame 60 / 65 / 77 / 80 mm  
106 / 126 mm 3 rails  
Sash 33 / 37 mm  
**Polyamide Strip Length**  
From 14,6 - 20 mm  
**Profile Thickness**  
Window 1,5 mm  
**Glazing**  
Max. 26 mm, Min. 9 mm

**Maximum Sash Dimensions**  
Width (L) 2200 mm  
Height (H) 2600 mm  
**Maximum Sash Weight**  
100 Kg 45° sash encounter  
200 Kg 90° sash encounter  
**Aesthetic possibilities:**  
Sash: Straight or curved  
Bead: Straight or curved

Consult maximum weight and dimensions according to typologies

### OPENING POSSIBILITIES



Sliding  
1, 2 and 3 rails  
Pocket possibility 1 and 2 rails



4200 SLIDING

5000

Double Sliding

Thermally broken double sliding window system with blind brackets inserted between the exterior and the interior sashes.

105

199

Sliding

OPENING POSSIBILITIES

FEATURES		
Transmittance		$U_w \geq 1,3$ (W/m <sup>2</sup> K)
Acoustic insulation		Rw hasta 40 dB
Air permeability		Class 3
Water tightness		Class 8A
Wind resistance		Class C5

Reference test 1,25 x 1,50 m / 2 sashes

**Sightlines**  
 Frame 199 mm  
 Sash 28 mm

**Polyamide Strip Length**  
 16 y 24 mm

**Profile Thickness**  
 Window 1,25 mm

**Glazing**  
 Max. 18 mm, Min. 4 mm

**Maximum Sash Dimensions**  
 Width (L) 1600 mm  
 Height (H) 2600 mm

**Maximum Sash Weight**  
 80 Kg

Consult maximum weight and dimensions according to typologies



Sliding  
 Thermally broken



5000

Sliding / Integral Sliding

Sliding system that integrates the blind bracket into the lateral frame. Also available in standard version.

FEATURES		
Transmittance		$U_w \geq 2,3$ (W/m <sup>2</sup> K)
Acoustic insulation		Rw up to 34 dB
Air permeability		Class 3
Water tightness		Class 8A
Wind resistance		Class C5

Reference test 1,20 x 1,20 m / 2 sashes

5000 Sliding

83

73

5000 Integral Sliding

100

121

**Sightlines**  
 5000 Sliding: Frame 73 mm, Sash 28 mm  
 5000 Integral Sliding: Frame 121 mm, Sash 28 mm

**Profile Thickness**  
 Window 1,5 mm

**Glazing**  
 Max. 18 mm, Min. 4 mm

OPENING POSSIBILITIES

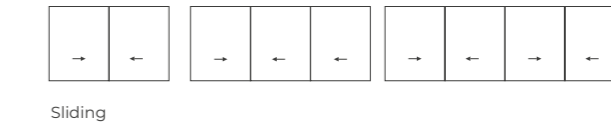

**Maximum Sash Dimensions**  
 Width (L) 1600 mm  
 Height (H) 2600 mm

**Maximum Sash Weight**  
 80 Kg

Consult maximum weight and dimensions according to typologies

Sliding



# MEDITERRANEAN

## Balcony

Sliding balcony solution for mild climates with straight aesthetic and 45° sash and frame encounters.

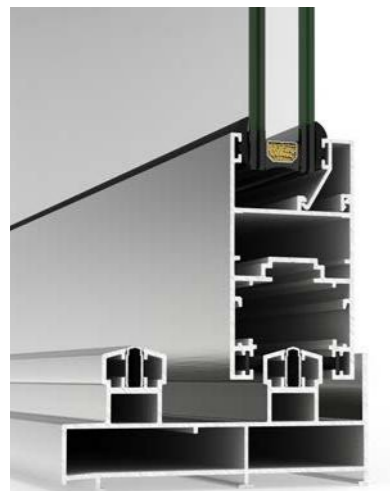

### Sightlines

Frame 106 mm / 161 mm tricarril

Sash 45 mm

### Profile Thickness

Balcony 1,5 mm

### Glazing

Max. 30 mm, Min. 4 mm

### Maximum Sash Dimensions

Width (L) 2200 mm

Height (H) 2600 mm

### Maximum Sash Weight

240 Kg

Consult maximum weight and dimensions according to typologies

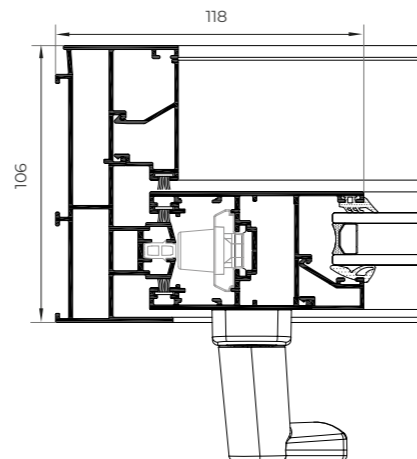

Sliding

### OPENING POSSIBILITIES



Sliding  
1 rail (sash + fixed light), 2 and 3 rails  
Pocket possibility

### FEATURES

Transmittance   $U_w \geq 2,1$  (W/m<sup>2</sup>K)

Acoustic insulation   $R_w$  up to 35 dB

Air permeability  Class 3

Water tightness  Class 8A

Wind resistance  Class C4

Reference test 1,49 x 1,24 m / 1 sash + 1 fixed light



MEDITERRANEAN BALCONY



# 2000

## Perimetral Sliding

Perimetral sliding system with the possibility of straight, curved or chamfered sashes.



### Sightlines

- Frame 40 mm 1 rail
- 40 / 45 / 60 / 70 mm 2 rails
- 80 mm 3 rails
- Straight and Chamfered sash 26 mm
- Curved sash 27,5 mm

### Profile Thickness

Window 1,5 mm

### Glazing

Max. 17 mm, Min. 3 mm

### Maximum Sash Dimensions

Width (L) 1600 mm  
Height (H) 2600 mm

### Maximum Sash Weight

160 Kg

Consult maximum weight and dimensions according to typologies

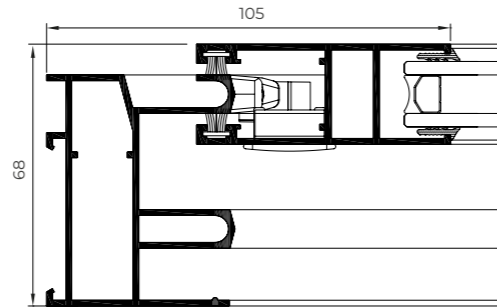

### Aesthetic possibilities:

Sash: Straight, curved or chamfered  
Bead: Straight or curved

### FEATURES

Transmittance		$U_w \geq 2,9$ (W/m <sup>2</sup> K)
Acoustic insulation		Rw up to 33 dB
Air permeability		Class 3
Water tightness		Class 8A
Wind resistance		Class C5

Reference test 1,20 x 1,20 m / 2 sashes

Sliding



# 6200

## Sliding

Sliding system recommended for mild climates with a profile thickness of 1,25 mm and a glazing capacity of 15 mm.

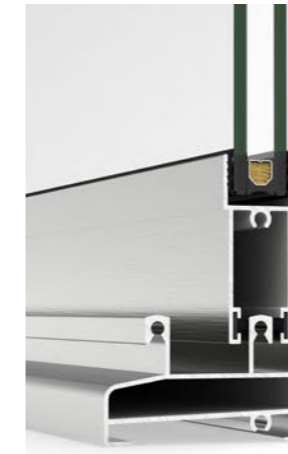

### Sightlines

- Frame 60 mm
- Sash 22 mm

### Profile Thickness

Window 1,25 mm

### Glazing

Max. 15 mm, Min. 4 mm

### Maximum Sash Dimensions

Window: Width (L) 800 mm, Height (H) 1600 mm  
Balcony: Width (L) 800 mm, Height (H) 2100 mm

### Maximum Sash Weight

80 Kg

Consult maximum weight and dimensions according to typologies

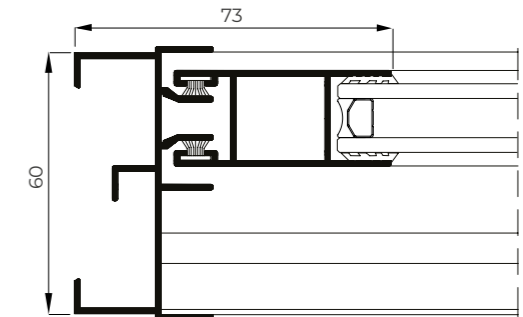

### OPENING POSSIBILITIES

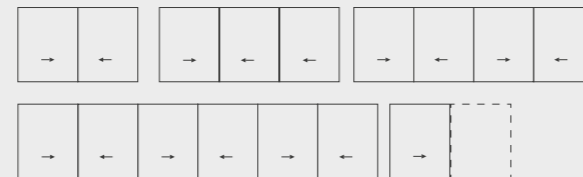

Sliding with 2, 3, 4 and 6 sashes  
Possibility of 1 and 3 rails  
Galandage possibility of 1 and 2 sashes

### OPENING POSSIBILITIES

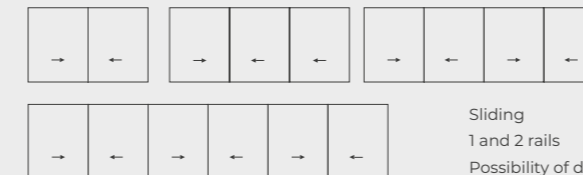

Sliding  
1 and 2 rails  
Possibility of double window

### FEATURES

Transmittance		$U_w \geq 3,2$ (W/m <sup>2</sup> K)
Acoustic insulation		Rw up to 35 dB
Air permeability		Class 3
Water tightness		Class 7A
Wind resistance		Class C3

Reference test 1,12 x 1,15 m / 2 sashes

Sliding



# 6500

## Sliding

Sliding door and window system with an average profile thickness of 1,5 mm for undemanding climates.



### Sightlines

Frame 83 mm

Sash 32 mm

### Profile Thickness

Window 1,5 mm

Door 1,5 mm

### Glazing

Max. 17 mm, Min. 4 mm

### Maximum Sash Dimensions

Width (L) 1900 mm

Height (H) 2600 mm

### Maximum Sash Weight

140 kg

Consult maximum weight and dimensions according to typologies

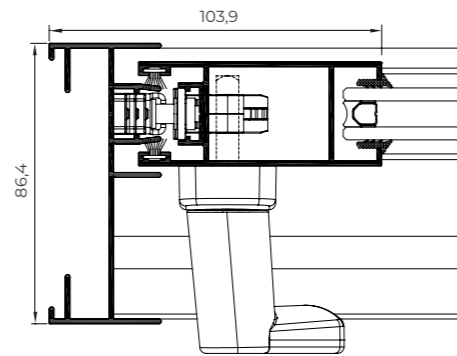

### OPENING POSSIBILITIES

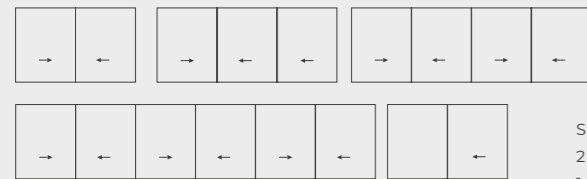

Sliding  
2 and 3 rails  
1 rail Pocket possibility

### FEATURES

Transmittance  $U_w \geq 2,2$  (W/m<sup>2</sup>K)

Acoustic insulation Rw up to 34 dB

Air permeability Class 3

Water tightness Class 7A

Wind resistance Class C4

Reference test 1,48 x 1,30 m / 2 sashes

Sliding



# 6500

## Plus Sliding

Window and door sliding system that allows an increase of the glazing capacity to up to 30 mm, thus improving the thermal and acoustic performance. Additionally, it has a interlock section of 40 mm that allows a larger glazed surface.

### FEATURES

Transmittance  $U_w \geq 2,0$  (W/m<sup>2</sup>K)

Acoustic insulation Rw up to 36 dB

Air permeability Class 3

Water tightness Class 7A

Wind resistance Class C4

Reference test 1,48 x 1,30 m / 2 sashes

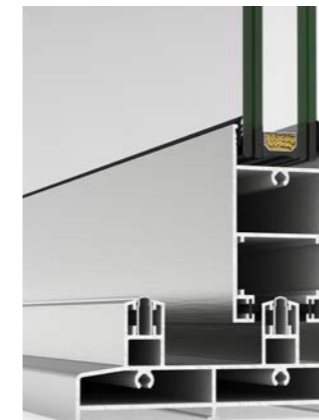
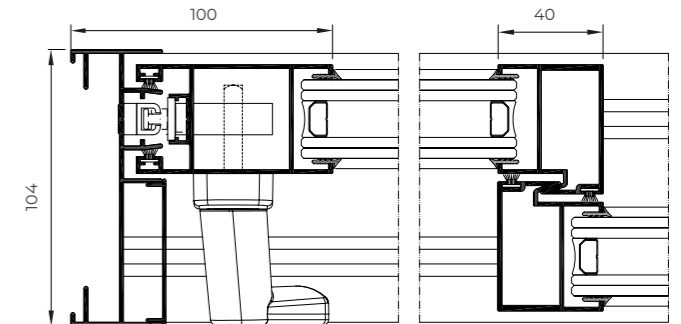

### Sightlines

Frame 104 mm / 158,1 mm (3 rails)

Sash 41,6 mm

### Profile Thickness

Window 1,5 mm

Door 1,5 mm

### Glazing

Max. 30 mm, Min. 18 mm

### Maximum Sash Dimensions

Width (L) 1900 mm, Height (H) 2600 mm

### Maximum Sash Weight

240 kg

Consult maximum weight and dimensions according to typologies

### OPENING POSSIBILITIES

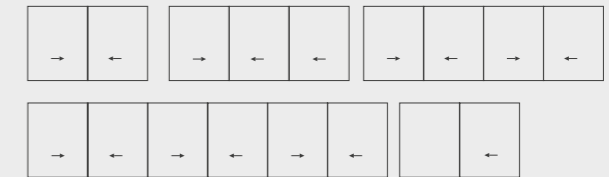

Sliding  
1 rail (sash + fixed light), 2 and 3 rails

Sliding



2000 PERIMETRAL SLIDING



6500 PLUS SLIDING



contemporary  
enclosures



cortizo **PVC**

# A 84

## Passivhaus HI

Hinged system with 84 mm of frame depth and 6 interior chambers that offers the best thermal performance in the market, with a transmittance value  $U_w$  of only  $0,66 \text{ W/m}^2\text{K}$ . This series has been certified by the Passivhaus Institute for cool-temperate category (cold and temperate weather), becoming an ideal solution for low energy consumption buildings. It includes special insulating foams in the sash and frame, disposing of the steel reinforcement to increase transmittance. The glass itself acts as a structural element of the window, fixed to the profile by a special adhesive tape.

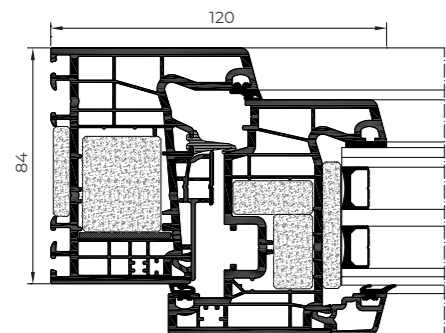

### FEATURES

Transmittance		$U_w \geq 0,66 \text{ (W/m}^2\text{K)}$
Acoustic insulation		Rw up to 46 dB
Air permeability		Class 4
Water tightness		Class E1500
Wind resistance		Class C5

Reference test 1,23 x 1,48 m / 2 sashes

PVC



### Aesthetic possibilities:

Sash: Straight / Bead: Straight or curved

### POSSIBILITIES



### Sightlines

Frame 84 mm, Sash 84 mm

### Glazing

Max. 56 mm, Min. 36 mm

### Maximum Sash Dimensions

Window:

Width (L) 450-1300 mm

Height (H) 450-2200 mm

Balcony:

Width (L) 450-1300 mm

Height (H) 600-2200 mm

### Maximum Sash Weight

100 kg

Consult maximum weight and dimensions according to typologies

### OPENING POSSIBILITIES



Inward Opening

Side hung  
Tilt & turn  
Bottom hung

# A 84

## Passivhaus 1.0 Thermally broken / Passivhaus 1.0

Certified for the warm-temperate category (warm-temperate weather), it offers a transmittance value  $U_w$  of  $0,74 \text{ W/m}^2\text{K}$ , thanks to the use of an internal reinforcement with thermal bridge breakage.



PVC



### FEATURES

Transmittance		$U_w \geq 0,74 \text{ (W/m}^2\text{K)}$
Acoustic insulation		Rw up to 46 dB
Air permeability		Class 4
Water tightness		Class E1500
Wind resistance		Class C5

Reference test 1,23 x 1,48 m / 2 sashes

### Aesthetic possibilities:

Sash: Straight

Bead: Straight or curved

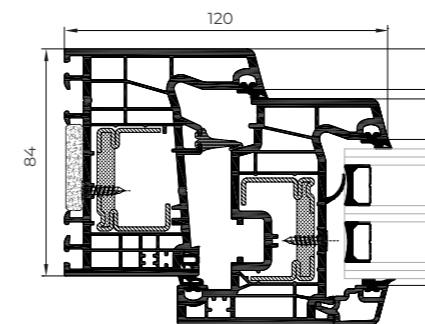

Passivhaus 1.0 Thermally broken

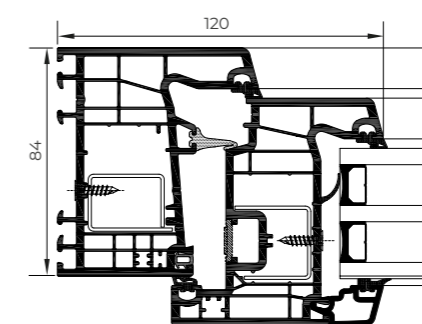

Passivhaus 1.0

### POSSIBILITIES



### OPENING POSSIBILITIES



Inward Opening

Side hung  
Tilt & turn  
Tilt & parallel  
Bottom hung



### Sightlines

Frame 84 mm, Sash 84 mm

### Glazing

Max. 54 mm, Min. 18 mm

### Maximum Sash Dimensions

Window:

Passivhaus 1.0:

Width (L) 450-1400 mm

Passivhaus 1.0 reduced reinforcement:

Width (L) 450-1300 mm

Passivhaus 1.0 /

Passivhaus 1.0 reduced reinforcement:

Height (H) 450-2200 mm

Balcony passivhaus 1.0:

Width (L) 450-1400 mm

Height (H) 600-2400 mm

### Maximum Sash Weight

130 kg





Consult maximum weight and dimensions according to typologies

# A 84

## Hinged

Hinged system with a 84 mm frame depth and 6 interior chambers with excellent thermal performance,  $U_w$  from 0,79  $W/m^2K$ , and a great acoustic performance thanks to its glazing capacity of up to 54 mm.

### FEATURES

Transmittance		$U_w \geq 0,79 (W/m^2K)$
Acoustic insulation		Rw up to 46 dB
Air permeability		Class 4
Water tightness		Class E1500
Wind resistance		Class C5

Reference test 1,23 x 1,48 m / 2 sashes

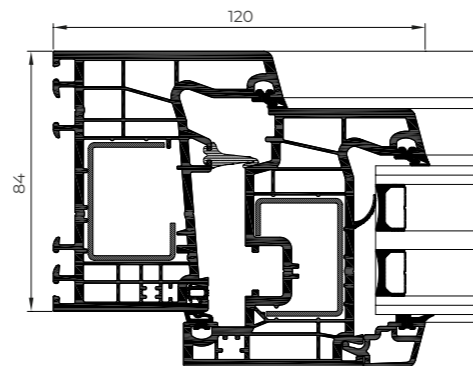

### Sightlines

Frame 84 mm

Sash 84 mm

### Glazing

Max. 54 mm, Min. 4 mm

### Maximum Sash Dimensions

Window:

Width (L) 450-1400 mm

Height (H) 450-2200 mm

Balcony:

Width (L) 450-1400 mm

Height (H) 600-2400 mm

Door:

Width (L) 700-1300 mm

Height (H) 600-2500 mm

### Maximum Sash Weight

130 Kg Window / Balcony

160 Kg Door

### Aesthetic possibilities:

Sash: Straight

Bead: Straight or curved

Consult maximum weight and dimensions according to typologies

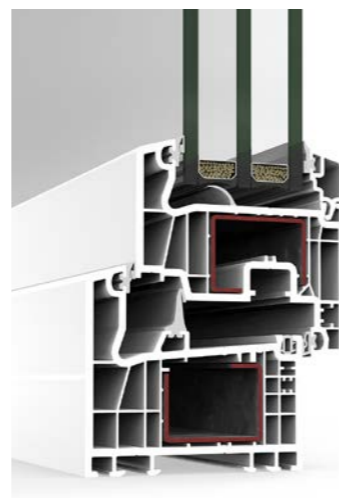

PVC



### A 84 PASSIVHAUS



A 84 HIDDEN SASH

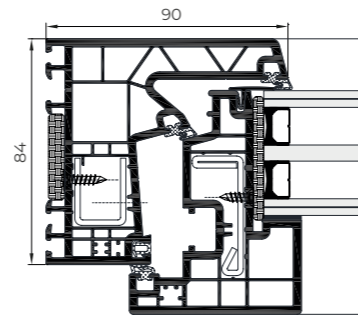

A 84 Hidden Sash Passivhaus

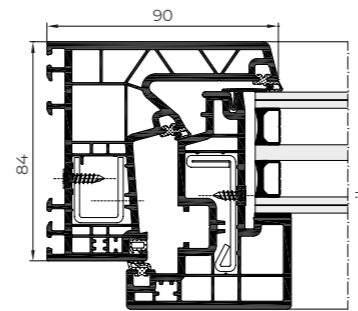

A 84 Hidden Sash

A 84

Hidden Sash Passivhaus / Hidden Sash

Minimalist window with an lateral sightline of only 90 mm and possibility of reduced central sightline of the same measure. This system with 84 mm of frame depth and 6 interior chambers combines elegant design with excellent thermal performance, in the Passivhaus version certified for the warm-temperate category ( $U_w$  from 0,71  $W/m^2K$ ) as well as in the standard version ( $U_w$  from 0,74  $W/m^2K$ ).

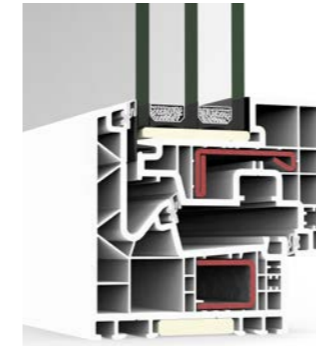

A 84 Hidden Sash Passivhaus



A 84 Hidden Sash

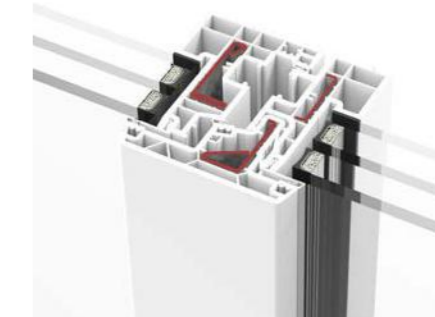

Possibility of 90 mm interlock section



Sightlines

Frame 84 mm, Sash 84 mm

Glazing

Max. 46,5 mm, Min. 32 mm  
Glazing: 46,5 mm (Passivhaus)

Maximum Sash Dimensions

Width (L) 400-1400 mm,  
Height (H) 450-2500 mm

Maximum Sash Weight

130 Kg Window / Balcony  
Consult maximum weight and dimensions according to typologies

FEATURES

Transmittance Passivhaus		$U_w \geq 0,71 (W/m^2K)$
Transmittance Standard		$U_w \geq 0,74 (W/m^2K)$
Acoustic insulation		Rw up to 46 dB
Air permeability		Class 4
Water tightness		Class E2250
Wind resistance		Class C5

Reference test 1,23 x 1,48 m / 2 sashes

POSSIBILITIES



SECURITY HARDWARE



CONCEALED HINGES



ACCESSIBILITY (A 84 HIDDEN SASH)



CONCEALED DRAINAGE (A 84 HIDDEN SASH)

OPENING POSSIBILITIES



Inward Opening

Side hung  
Tilt & turn  
Bottom hung

# A 70

## Hinged

Hinged system with 70 mm of frame depth with a maximum glazing capacity of 40 mm. The 5 interior chambers in the frame and sash allows for great energy efficiency with a transmittance value  $U_w$  from 0,9 W/m<sup>2</sup>K. Possibility of straight, curved or chamfered sashes.



### Sightlines

Frame 70 mm  
Sash 70 / 80 mm

### Glazing

Max. 42 mm / Min. 4 mm

### Maximum Sash Dimensions

Window:

Width (L) 360 - 1300 mm  
Height (H) 450 - 2300 mm

Balcony:

Width (L) 360 - 1300 mm  
Height (H) 600 - 2400 mm

Door:

Width (L) 700 - 1300 mm  
Height (H) 600 - 2500 mm

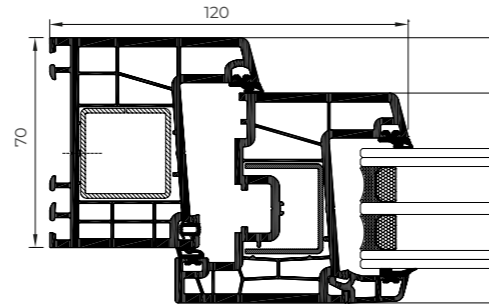

PVC

### OPENING POSSIBILITIES

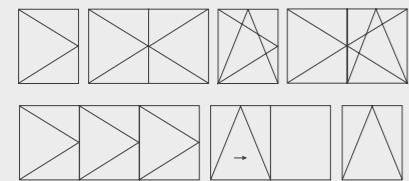

Inward Opening      Outward Opening  
Side hung  
Tilt & turn  
Bi-fold  
Tilt & parallel  
Bottom hung

### Maximum Sash Weight

130 kg Window  
130 Kg Balcony  
160 Kg Door

### Aesthetic possibilities:

Sash: Straight, curved or chamfered  
Bead: Straight or curved

Consult maximum weight and dimensions according to typologies

### POSSIBILITIES



SECURITY HARDWARE



ACCESSIBILITY



CONCEALED DRAINAGE

### FEATURES

Transmittance		$U_w \geq 0,9$ (W/m <sup>2</sup> K)
Acoustic insulation		Rw up to 46 dB
Air permeability		Class 4
Water tightness		Class E1800
Wind resistance		Class C5

Reference test 1,23 x 1,48 m / 2 sashes

# A 70

## Hinged Triple Seal

It offers the possibility of a minimalist central sightline of only 127 mm, maximizing the glazed surface and increasing luminosity in indoor areas. It includes a central gasket that creates a hermetically sealed chamber around the hardware, protecting it from possible humidity or condensation and the action of external factors, thus prolonging its service life.

### FEATURES

Transmittance		$U_w \geq 0,9$ (W/m <sup>2</sup> K)
Acoustic insulation		Rw up to 46 dB
Air permeability		Class 4
Water tightness		Class E1500
Wind resistance		Class C5

Reference test 1,23 x 1,48 m / 2 sashes

### POSSIBILITIES



SECURITY HARDWARE



CONCEALED DRAINAGE

### OPENING POSSIBILITIES

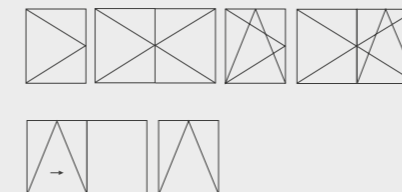

Inward Opening  
Side hung  
Tilt & turn  
Tilt & parallel  
Bottom hung

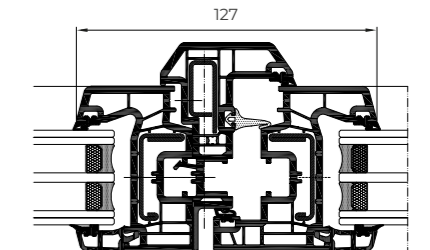
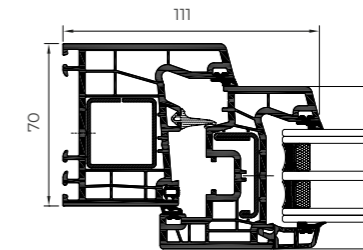

PVC

### Sightlines

Frame 70 mm, Sash 70 mm

### Glazing

Max. 42 mm, Min. 10 mm

### Maximum Sash Dimensions

Window:

Width (L) 1200 mm  
Height (H) 1450 mm

Balcony:

Width (L) 1000 mm  
Height (H) 2200 mm

### Maximum Sash Weight

100 kg Window  
130 Kg Balcony

Consult maximum weight and dimensions according to typologies





## CORTIZO QUALITY PVC

### Class A

Main walls thickness:  
3 mm

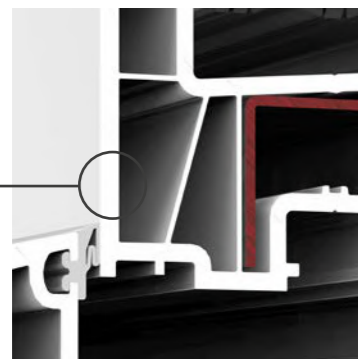

### Class S

#### Climatic zones

7 parts of titanium dioxide.  
Maximum resistance to solar incidence

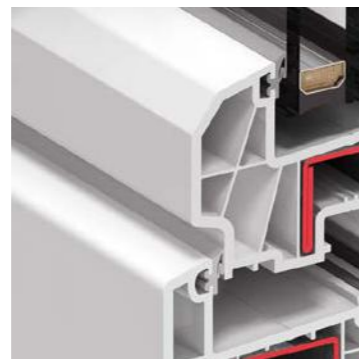

### Class II

#### Impact resistance

Maximum profile hardness



A 70 HINGED

# ALCOVER

Mixed window system that multiplies the aesthetic possibilities of the PVC A 70 series, covering the external face of the window with an aluminium profile clipped on the frame and sash, with 45° or 90° profile encounters.

This solution, ideal for rehabilitation, allows the combination of the excellent performance of PVC systems and the great variety of painted powdercoated and anodized finishes aluminium offers.

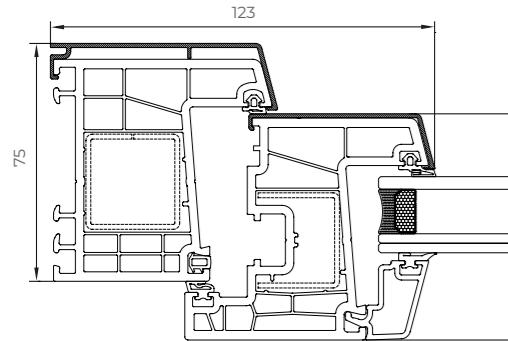

## OPENING POSSIBILITIES



Inward opening  
Side hung  
Tilt & turn  
Bottom hung

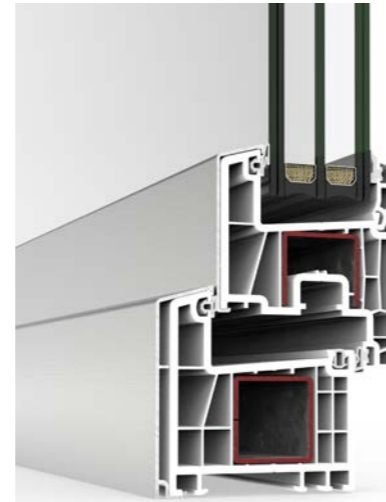

## FEATURES

Transmittance		$U_w \geq 0,9 (W/m^2K)$
Acoustic insulation		Rw up to 46 dB
Air permeability		Class 4
Water tightness		Class E1800
Wind resistance		Class C5

Reference test 1,23 x 1,48 m / 2 sashes

PVC



## POSSIBILITIES



SECURITY  
HARDWARE



Alcover 45° profile encounters



Alcover 90° profile encounters

## Sightlines

Frame 75 mm, Sash 71 mm

## Glazing

Max. 42 mm, Min. 18 mm

## Maximum Sash Dimensions

Window:

Width (L) 360 - 1300 mm

Height (H) 450 - 2300 mm

Balcony:

Width (L) 360 - 1300 mm

Height (H) 600 - 2400 mm

## Maximum Sash Weight

130 kg Window

130 Kg Balcony

Consult maximum weight and dimensions according to typologies



PVC







# C 70

## Sliding

Sliding window and balcony system with 70 mm of frame depth and optimal thermal and acoustic performances. Possibility of minimalist sash with only 75 mm of interlock profile.

### FEATURES

Transmittance		$U_w \geq 1,3$ (W/m <sup>2</sup> K)
Acoustic insulation		Rw up to 38 dB
Air permeability		Class 4
Water tightness		Class 7A
Wind resistance		Class C5

Reference test 1,23 x 1,48 m / 2 sashes

### POSSIBILITIES



### OPENING POSSIBILITIES

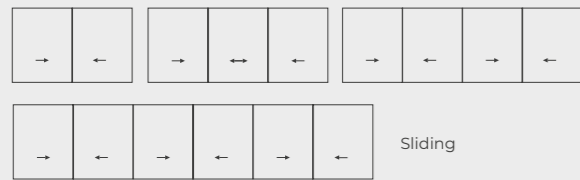

PVC

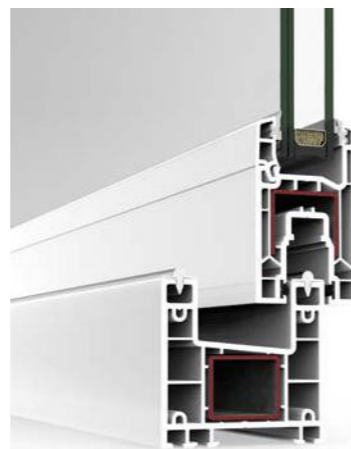
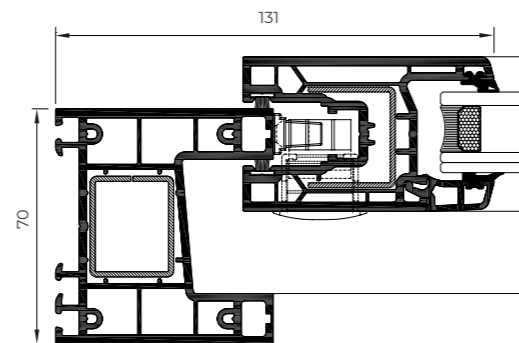

### Sightlines

Frame 70 mm, Sash 46 mm

### Glazing

Max. 26 mm, Min. 4 mm

### Maximum Sash Dimensions

Window:

Width (L) 1400 mm

Height (H) 1800 mm

Balcony:

Width (L) 2000 mm

Height (H) 2500 mm

### Maximum Sash Weight

70 kg Window

200 Kg Balcony

Consult maximum weight and dimensions according to typologies

## C 70 SLIDING



# E 170

## Lift & Slide

Designed for large span enclosures with sashes of up to 3 m wide and 2.80 m high. It includes a hardware system that slightly elevates the sash when the handle is operated, facilitating its movement in the opening and closing motions. This system has a frame depth of 170 mm and a maximum glazing capacity of 40 mm, offering remarkable thermal and acoustic performances.

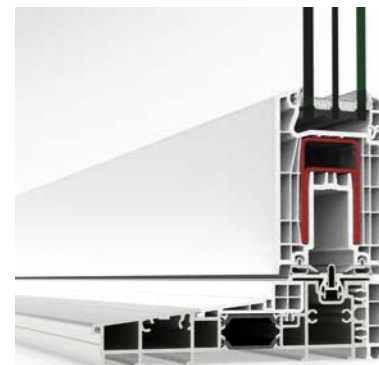

### Sightlines

Frame 170 mm, Sash 70 mm

### Glazing

Max. 40 mm, Min. 18 mm

### Maximum Sash Dimensions

Width (L) 3300 mm, Height (H) 2800 mm

### Maximum Sash Weight

300 kg

Consult maximum weight and dimensions according to typologies

### FEATURES

Transmittance		$U_w \geq 0,9 (W/m^2K)$
Acoustic insulation		Rw up to 42 dB
Air permeability		Class 4
Water tightness		Class 7A

Reference test 3,5 x 2,5 m / 1 sash + 1 fixed light

PVC

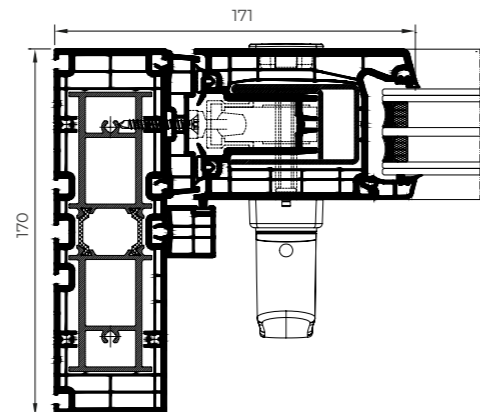

### POSSIBILITIES



### OPENING POSSIBILITIES

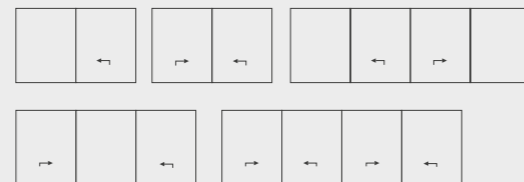

Lift & slide system of 1, 2 and 4 sashes

### E 170 LIFT & SLIDE





# CORTIZO ISOLATION

## Shutter Box

This system, exclusive to all CORTIZO PVC series, offers the best thermal isolation in the market with a transmittance value  $U_{sb}$  from  $0,66 \text{ W/m}^2\text{K}$ , rounding off the catalogue of enclosure systems for zero-energy buildings. Additionally, it offers excellent acoustic benefits with a noise attenuation of up to 44 db, and an elegant design with maximum quality materials and accessories.

### FEATURES

Transmittance		$U_{sb} \geq 0,66 \text{ (W/m}^2\text{K)}$
Acoustic insulation		Rw up to 44 dB
Air permeability		Class 4
Water tightness		Class E2250
Wind resistance		Class 3000 Pa (P3)

Reference test 200 x 230 mm (height x depth) y 1230 mm length

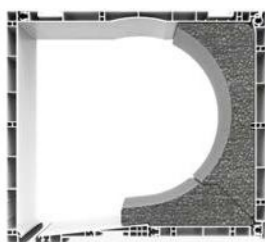

Thermal insulation

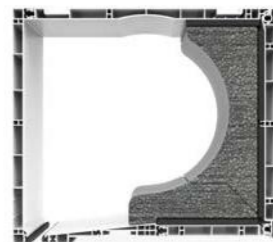

Thermal-acoustic insulation



Lateral Connection Link Rod  
Longitudinal Stability

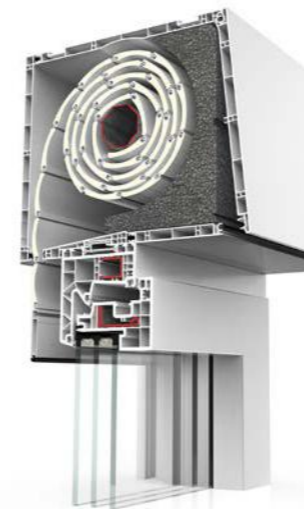
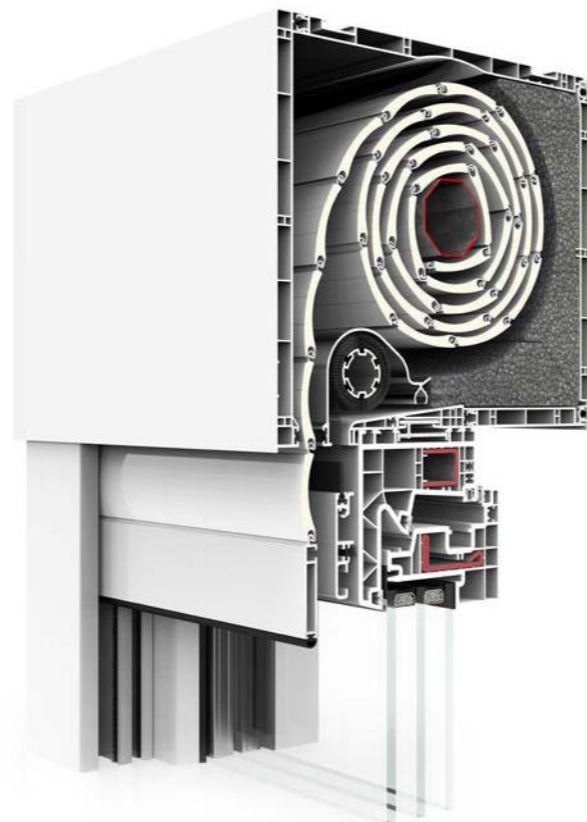

Frontal Register



Bottom Register

### Register Options

- Frontal
- Bottom

### Maximum Dimensions

- Width (L) 2300 mm (3800 mm with divider)
- Height (H) 2500 mm

### Versatility

- Possibility of using shutters with profiled, extrusion, or autoblocates extrusion blades.
- Possibility of motorized or manual shutters activated by belt or cardan.
- Possibility of integrated insect screen.

Consult maximum weight and dimensions according to typologies



### Profile junction

Provided with a hidden sealing gasket  
Registered and exclusive water-tightness system <sup>®</sup>

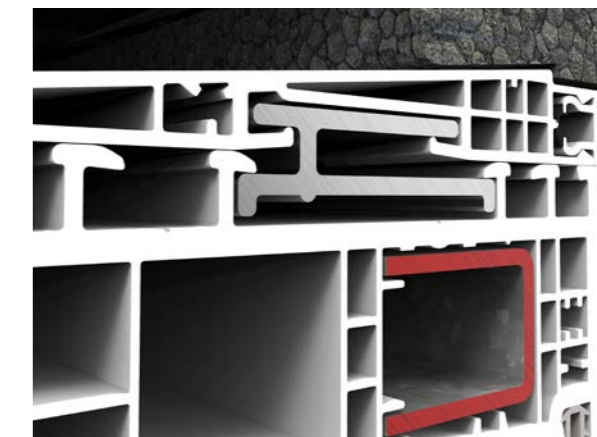

### Connection profile in aluminium

Longitudinal Stability

contemporary  
enclosures



**façade** systems



Cortizo's Department of Engineering for Building Envelopes is directed towards the design of custom envelopes for large dimension projects and technical complexity.



// Finished projects

\_ Puerto de Somport 2122 office building  
Spain

## DESIGN

Custom profile development, detail preparation and on-site consultation. Calculation and dimensioning of profiles, fixings, accessories, composite panel and glazing. 3D visualisation and renderings.



## FEATURES

The analysis executed in the CORTIZO Technological Centre allow us to test the façades' behaviour when faced with the most extreme conditions, for exemple earthquakes, hurricanes, fires... Additionally; our laboratory also examines the thermal and acoustic performances of all the developed systems, as well as their behaviour in air, water and wind tests.

## COMPREHENSIVE ASSISTANCE

85 engineers provide the necessary technical assistance in each of the project's phases, from the initial design phase, calculations, pricing, as well as the planning and control of deliveries.

# UNIT 66

## MODULAR FAÇADE

Thermally broken façade system suitable for high rise enclosure projects. This solution combines excellent performance with a wide range of custom designs, offering great aesthetic versatility with option of "glass only" or "seen profile" with an interlock profile of 66 mm. Its fixing bracket has three-dimensional regulation, facilitating its installation.

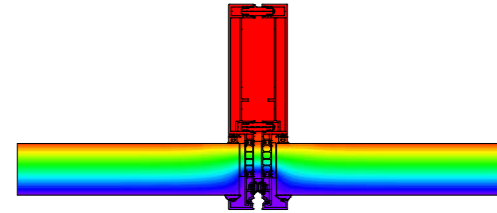

- Maximum weight:** 350 kg
- Glazing:** 58 mm
- Interlock profile:** 66 mm or 76 mm
- Thermal break zone:** 25 mm - 40 mm
- Separation between modules:** 10 or 20 mm
- Maximum dimensions:** Width (L) 1500 mm, Height (H) 3700 mm



### FEATURES

Transmittance		$U_{cw} \geq 0,6 (W/m^2K)$
Air permeability		Class AE
Water tightness		Class REI200
Wind resistance *		APTO
Impact resistance		I5 / E5

\* Design loading 2000 Pa-Security loading 3000 Pa

### OPENING POSSIBILITIES

- Outward Opening
- Hidden top hung
- Hidden parallel opening



Beaded version

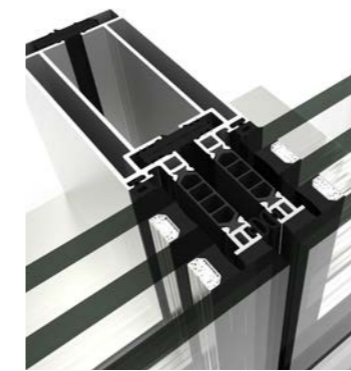

Structural version

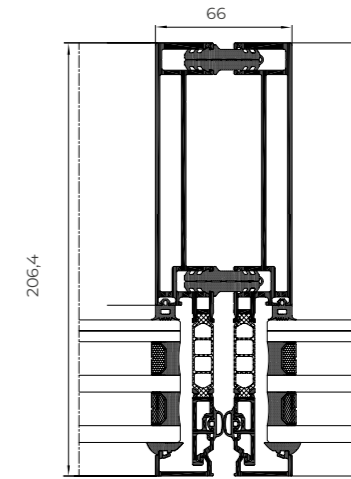

Standard version

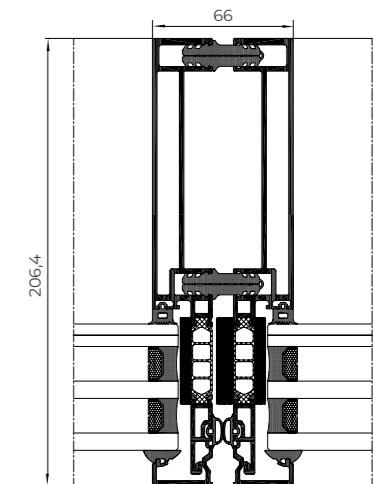

High insulation version





\_ Mol Arena Stadium-Dunajska Streda  
Slovakia

## FAÇADES

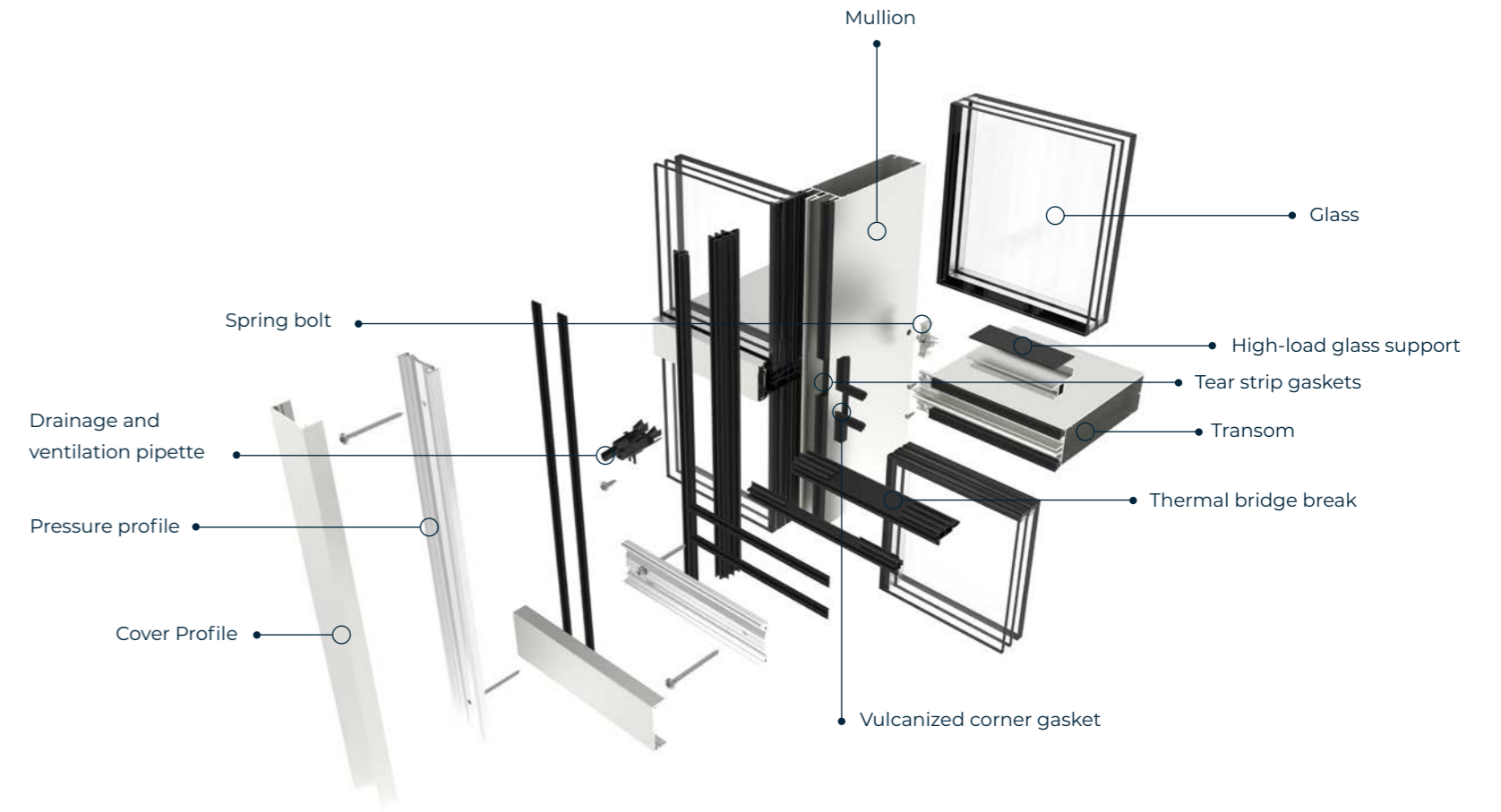

## WATER-TIGHTNESS ELEMENTS

Two plastic accessories are used to guide the water from possible condensation towards the exterior:

### Continuity piece

It carries the water that descends from the upper mullion's drainage channels over to the one immediately below in the fillet zone between them.

### Pipette

Collects the water from the mullion's (and, generally, from the annexed transoms') drainage channels and expels it into the space between the pressor and the cover, away from the areas that are affected by water tightness. Suitable for the TP 52 and TPV 52 systems.

In order to ensure water tightness in the mullion-transom meeting points, CORTIZO façades offer two solutions:

### Tear strip gaskets

Located inside the mullion with a crease that enables partial tearing in the meeting point with the transom, without leaving the union of the horizontal and vertical profile unprotected.

### Vulcanized corner gasket

This piece is obtained through moulding, which allows the integration of the gaskets of different mullion and transom thickness and, at the same time, isolates the contact zone of the vertical and horizontal profiles.



Continuity piece



Pipette



Tear strip gaskets



Totally vulcanized corner

## DRAINAGE LEVELS

CORTIZO façades have been designed so that the drainage channels of mullions and transoms of different levels are found in different planes. By doing this, the possible condensations will be led from the transoms' outer channels to the mullions and, from there, towards the exterior through the continuity pieces and the pipettes.

These same channels are used, simultaneously, to internally ventilate the four sides of the glass.



ARCH  
INVISIBLE  
FACADES

### New handle embedded into the profile

Minimalist design invisible from the frontal view.

Available for top hung and parallel openings in the CORTIZO façade systems TP 52, TPH 52, TPV 52 and SG 52.

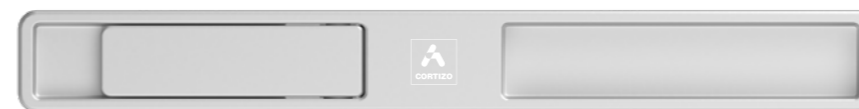



## TP 52 FAÇADE

Light façade system composed of 52 mm mullions and transoms that form the support structure. The glass is fixed at its four sides by a continuous pressure profile that is externally screwed to the screw ports incorporated in the mullions and transoms, concealing the entire fixing system under an embellishing profile or cover with an interlock profile of 52 mm.

### FEATURES

Transmittance		$U_{cw} \geq 0,6 (W/m^2K)$
Air permeability		Class AE
Water tightness		Class RE1350
Wind resistance *		PASSED

Reference test 3,00 x 3,50 m  
 Certification CWCT British Standard  
 \* Design loading 2000 Pa-Security loading 3000 Pa



TP 52 FAÇADE

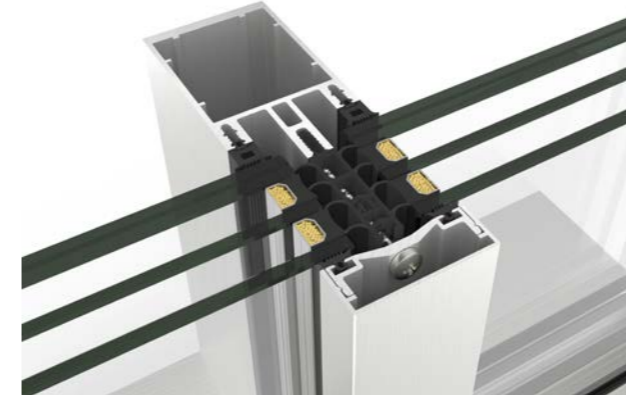

### Glazing

Max. 64 mm, Min. 4 mm

### Sightlines

Mullion 52 mm  
 Transom 52 mm

### Profile Thickness

Mullion 2,1 and 3,0 mm  
 Transom 2,1 mm

### Thermal Break Zone

6, 12 and 30 mm stackable profiles

### Cover

85 mm deep elliptical cover  
 H shape cover, 34 mm deep  
 Rectangular cover: 14, 19 100 & 145 mm deep  
 Flat cover  
 Pyramid shape cover, 155 mm deep

### Minimum / Maximum opening dimensions

**Hidden Top Hung:**  
 Width (L) 2500 - 500 mm, Height (H) 2500 - 650 mm

**Hidden Side Hung / Tilt & Turn:**  
 Width (L) 1400-500 mm, Height (H) 1900-600 mm

**Hidden Parallel:**  
 Width (L) 1500-450 mm, Height (H) 3000-650 mm

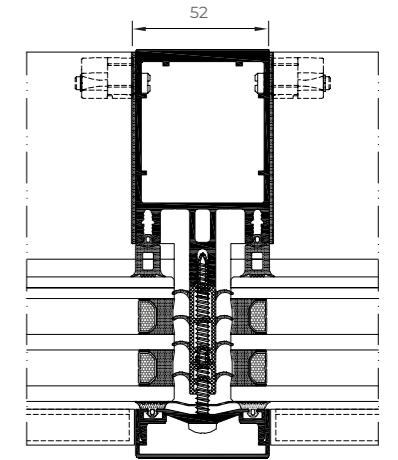

### OPENING POSSIBILITIES

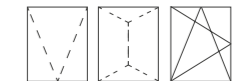

Outward Opening

Hidden top hung  
 Hidden parallel

Inward Opening

Hidden side hung / tilt & turn





### Maximum Weight

200 kg Parallel opening  
 180 kg Hidden top hung opening  
 100 Kg Tilt & turn opening  
 750 Kg Fixed glazing

# SG 52 FAÇADE

Curtain wall system with a glass only external aesthetic, this glass is fixed to the supporting profiles by a combination of clips and a U profile fitted into the glazing chamber.

## FEATURES

Transmittance		$U_{cw} \geq 0,6 (W/m^2K)$
Air permeability		Class AE
Water tightness		Class RE1500
Wind resistance *		PASSED

Reference test 3,00 x 3,50 m  
 Certification CWCT British Standard  
 \* Design loading 2000 Pa-Security loading 3000 Pa

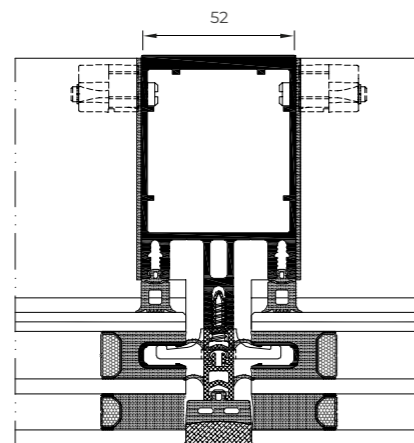

**Glazing**  
 Max. 64 mm, Min. 6 mm  
**Sightlines**  
 Mullion 52 mm  
 Transom 52 mm  
**Profile Thickness**  
 Mullion 2,1 and 3,0 mm  
 Transom 2,1 mm  
**Thermal break zone**  
 6, 12 and 30 mm stackable profiles



### Minimum / Maximum opening dimensions

Maximum Width. (L) 2500 mm  
 Minimum Width (L) . 500 mm  
 Maximum Height (H) 2500 mm  
 Maximum Height. (H) 650 mm

**Maximum Weight**  
 180 kg Hidden top hung opening  
 750 Kg Fixed lights

### OPENING POSSIBILITIES

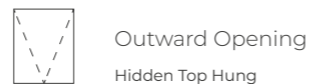

Façades



SG 52 FAÇADE





FACHADA TPH 52

## TPH 52 FAÇADE

Façade solution based on the combination of the TP 52 and SG 52 systems. The glass is fixed by the pairing of the pressure profile and the cover profile on the horizontal gaskets, and it uses clips and the U-profile for its vertical edge.



### OPENING POSSIBILITIES



Outward Opening  
Hidden Top Hung

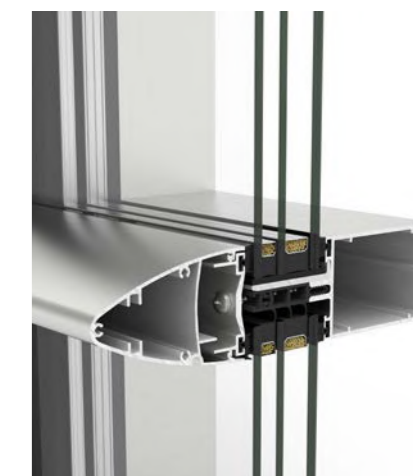
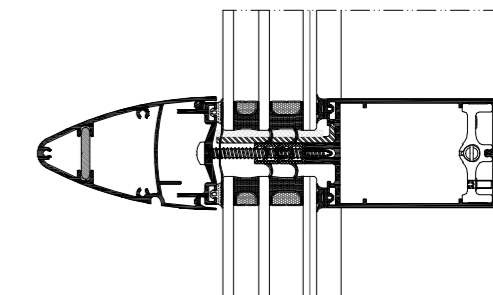

### Glazing

Max. 64 mm, Min. 6 mm

### Sightlines

Mullion 52 mm

Transom 52 mm

### Profile Thickness

Mullion 2,1 and 3,0 mm

Transom 2,1 mm

### Covers

Flat cover

Rectangular cover: 14, 19 100 & 145 mm deep

H shape cover, 34 mm deep

85 mm deep elliptical cover

### Minimum / Maximum opening dimensions

Hidden Top Hung:

Maximum Width (L) 2500 mm

Minimum Width (L) 500 mm

Maximum Height (H) 2500 mm

Minimum Height (H) 650 mm

### Maximum Weight

180 kg Hidden top hung opening

750 Kg Fixed lights

### FEATURES

Transmittance   $U_{cw} \geq 0,6$  (W/m<sup>2</sup>K)

Air permeability  Class AE

Water tightness  Class RE1500





Wind resistance \*  PASSED

Reference test 3,00 x 3,50 m  
Certification CWCT British Standard  
\* Design loading 2000 Pa-Security loading 3000 Pa

# TPV 52 FAÇADE

Curtain wall system based on the combination of the TP 52 and SG 52 systems. The glass is fixed by the pairing of the pressure profile and the cover profile on its vertical edge, and it uses clips and the U-profile for the horizontal gaskets.

## FEATURES

Transmittance		$U_{cw} \geq 0,6 (W/m^2K)$
Air permeability		Class AE
Water tightness		Class RE1500
Wind resistance *		PASSED

Reference test 3,00 x 3,50 m  
 Certification CWCT British Standard  
 \* Design loading 2000 Pa-Security loading 3000 Pa

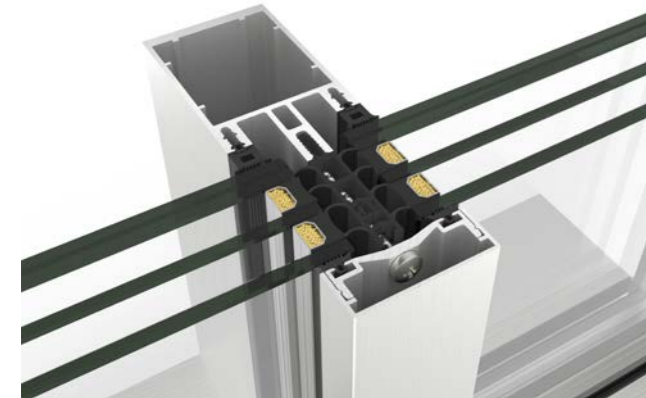

### Glazing

Max. 64 mm, Min. 6 mm

### Sightlines

Mullion 52 mm

Transom 52 mm

### Thermal Break Zone

6, 12 and 30 mm stackable profiles

### Profile Thickness

2,1 and 3,0 mm

2,1 mm

### Covers

Flat cover

H shape cover, 34 mm deep

Rectangular cover: 14, 19 100 & 145 mm deep

### Maximum Weight

180 kg Hidden top hung opening

750 Kg Fixed lights

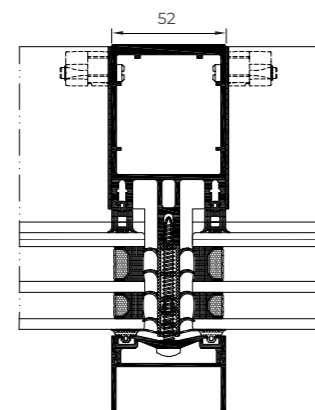

Façades



### Minimum / Maximum opening dimensions

Top Hung Opening

Max. Width (L) 2500 mm, Min. Width (L) 500 mm

Max. Height (H) 2500 mm, Min. Height (H) 650 mm



### OPENING POSSIBILITIES



Outward Opening

Hidden Top Hung



TPV 52 FAÇADE

## ST 52 FAÇADE

In this façade system, the glass is glued with structural silicone to an aluminium frame, which is then glued to the main structure. It has an open groove glass only external aesthetic with EPDM gaskets in the perimeter of each module in order to guarantee water tightness. An overlap closes the space between the gaskets.

### OPENING POSSIBILITIES



Outward Opening  
Hidden Top Hung



### Glazing

Max. 38 mm, Min. 6 mm

### Sightlines

Mullion 52 mm

Transom 52 mm

### Profile Thickness

Mullion 2,1 and 3,0 mm

Transom 2,1 mm

### Maximum Weight

180 kg Top hung opening

350 Kg Fixed lights

### Minimum / Maximum opening dimensions

Top Hung Opening

Max. width (L) 2500 mm, Min. width (L) 500 mm

Max. height (H) 2500 mm, Min. height (H) 650 mm

### FEATURES

Transmittance   $U_{cw} \geq 0,7$  (W/m<sup>2</sup>K)

Air permeability  Class AE

Water tightness  Class RE750

Wind resistance \*  PASSED

Reference test 3,00 x 3,50 m  
Certification CWCT British Standard

\* Design loading 2000 Pa-Security loading 3000 Pa

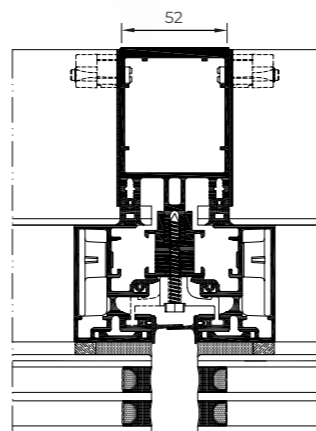

Façades

## SST 52 FAÇADE

The glass is mechanically fixed to the aluminium frame with an external embellishing profile without the need of structural silicone as is the case in the TP 52 system. It also has an open groove external aesthetic, in this case by covering the glass with aluminium. The EPDM gasket is installed in the perimeter of each module, acting as a water tightness first line of defence. An overlap closes the space between the gaskets.

### FEATURES

Transmittance   $U_{cw} \geq 0,8$  (W/m<sup>2</sup>K)

Air permeability  Class AE

Water tightness  Class RE750

Wind resistance \*  PASSED

Reference test 3,00 x 3,50 m  
Certification CWCT British Standard

\* Design loading 1200 Pa-Security loading 1800 Pa

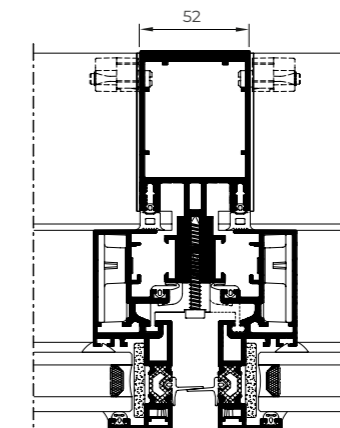

### Glazing

Max. 28 mm, Min. 6 mm

### Sightlines

Mullion 52 mm

Transom 52 mm

### Thermal Break Zone

18 mm

### Profile Thickness

Mullion 2,1 and 3,0 mm

Transom 2,1 mm

### Maximum Weight

180 kg Top hung opening

350 Kg Fixed lights

### Minimum / Maximum opening dimensions

Max. width (L) 2500 mm, Min. width (L) 500 mm

Max. height (H) 2500 mm, Min. height (H) 650 mm

### OPENING POSSIBILITIES



Outward Opening  
Hidden Top Hung

Façades



ST 52 FAÇADE



SST 52 FAÇADE





## EQUITY FAÇADE

This system is characterised by a slim and minimalistic aesthetic with an interlock profile of only 18 mm both in mullions and transoms, which are also the same depth. This creates a flush mounting that provides the façade a uniform aesthetic. The glazing of this curtain wall is compatible with the TP 52, TPH 52, TPV 52 and SG 52 series.

Transmittance   $U_{cw} \geq 0,6 (W/m^2K)$

### Glazing

Max. 64 mm, Min. 4 mm

### Sightlines

Mullion 18 mm

Transom 18 mm

### Profile Thickness

2,6 mm (Mullion and Transom)

### Covers

Flat cover.

85 mm deep elliptical cover.

H shape cover, 34 mm deep.

Rectangular cover: 14, 19 100 & 145 mm deep

Pyramid shape cover, 155 mm deep

6, 12 & 30 mm stackable thermal break profiles

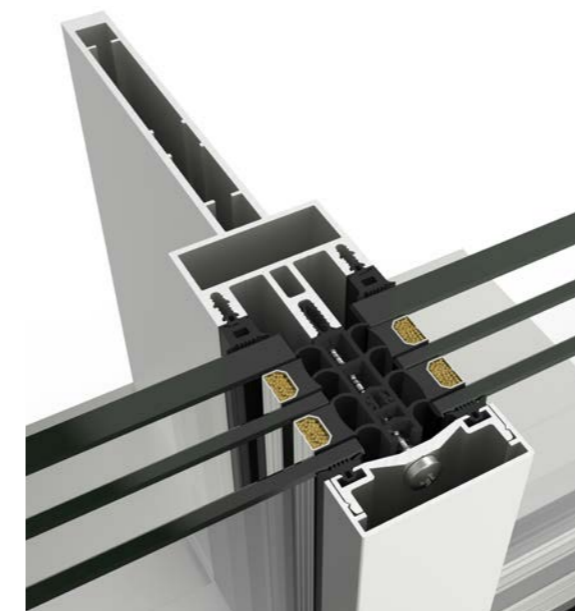
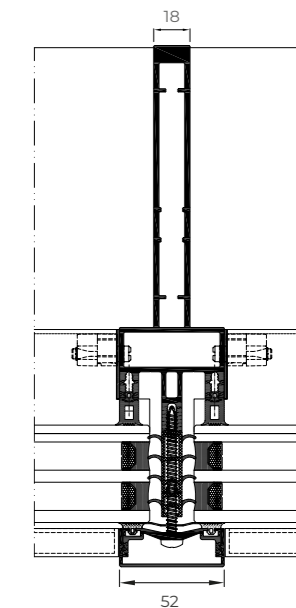



# VERANDA

Gable or hipped roofing system comprised of flush mullions and transoms for 1st, 2nd, and 3rd level that allow for different drainage levels, guaranteeing perfect outflow of water, ventilation and water tightness.

Possibility of motorized top hung opening in roof areas. This skylight system allows for an easy integration of our veranda systems, our hinged windows or our sliding window/door systems.

## OPENING POSSIBILITIES



Outward opening  
Motorized top hung



## FEATURES

Transmittance		Ucw ≥ 0,6 (W/m²K)
Air permeability		Class AE
Water tightness		Class RE1350
Wind resistance *		PASSED

Reference test 3,00 x 3,50 m  
\* Design loading 1200 Pa-Security loading 1800 Pa

## PROJECTING OPENING TEST

Air permeability		Class 4
Water tightness		Class E2100
Wind resistance		Class C5

Window reference test 1,23 x 1,14 mm / 1 sash

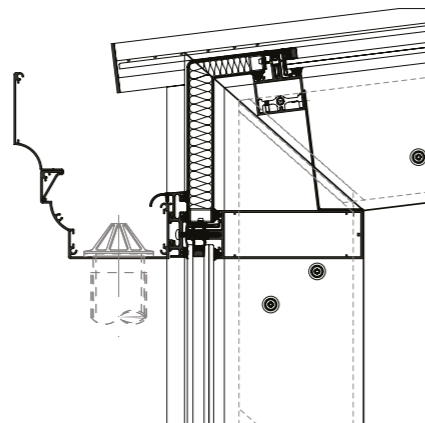

## Sightlines

Mullion 52 mm  
Transom 52 mm

## Profile Thickness

2,1 & 3,0 mm  
2,1 mm

## Glazing

Fixed lights:  
Max. 38 mm, Min. 26 mm

Window roof:  
Max. 38 mm, Min. 24 mm

**Minimum incline/slope Pt:** 12% (7°)

**Maximum incline/slope Pt:** 85% (40°)

## VERANDA



# SLIDING ROOF

Sliding and automatic enclosure system that allows the opening and closing of a roofed area, allowing to enjoy the fresh air or a roofed space depending on the circumstances. This solution grants a 66% maximum opening of the span, featuring, in addition, a notable thermal and acoustic comfort thanks to its glazing capacity of 24 mm and the installation of solar control glass. CORTIZO's Sliding Roof is equipped with a series of complementary profiles that adjust the enclosure's water collection and drainage, thus guaranteeing the system's maximum water tightness.

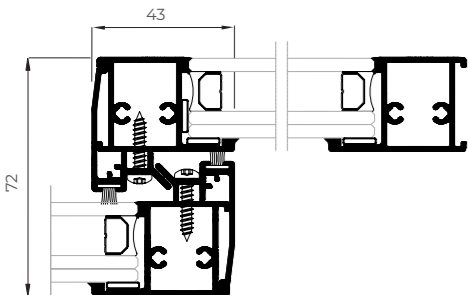
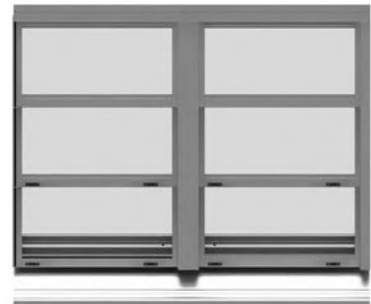

### Sightlines

Frame 133 mm  
Sash 28 mm

### Profile Thickness

Sashes 1,5 mm

### Glazing

Cellular polycarbonate 25 mm  
Sandwich panel 24 mm  
Glass 24 mm (4 tempered / 12 / 4+4)

### Maximum Sash Dimensions

Width (L)  
2300 mm (polycarbonate and sandwich panel)  
1200 mm (glass)  
Height (H) 1600 mm

### Maximum Sash Weight:

75 Kg

Sliding  
Roof



### OPENING POSSIBILITIES

▽	▽	▽	▽
▽	▽	▽	▽

### Outward Opening

2 sashes and 1 fixed module and multiple falls

### Maximum Span Opening: 66%

Incline/Slope: 8,5% (15°)

### Roof Distance

Max. 4800 mm, Min. 3100 mm

### Roof Width

Unlimited when joining modules

### Motorised sash opening

### Roof system watertightness test: Class APT

During the 6 hr. test, end of test and 24 hrs. following the same, no drips or humidity were detected in the enclosed area  
Reference test: 4300 x 4160 mm in 3 adjustable rows, 9 sashes and 4 / 12 / 4+4 glass

## SLIDING ROOF



contemporary  
enclosures



**interior divisions** systems



PW80 OFFICE PARTITION WALL

## PW 80

### Office Partition Wall

Designed to divide interior spaces, available in glass and panel version. This solution allows the integration of side hung doors and venetian blinds.

#### FEATURES

Glazing	6+6, 8+8, 10+10, 12+12 mm
Sections	80 mm (mullion)
Profile thickness	1,5 mm (mullion)
Panel	10 - 20 mm
Sightlines	12 / 24 / 36 mm
Máx. weigh	40 Kg
Opening possibilities	8 and 10 mm Glass side hung Door 40 mm Panel side hung Door

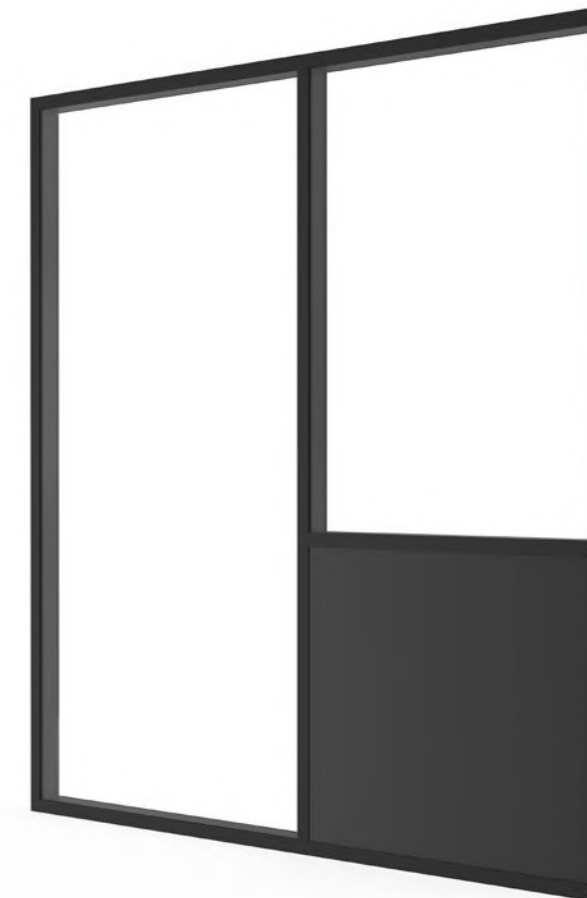
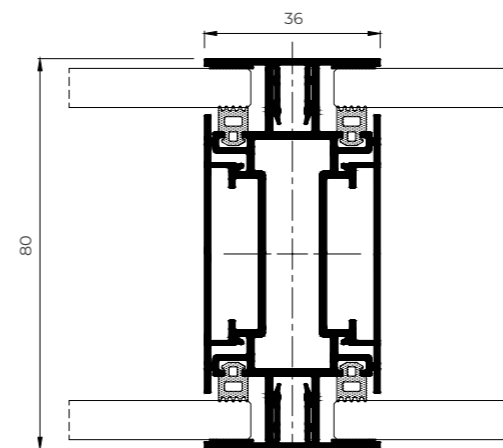

contemporary  
enclosures



**solar protection** systems

# SOLAR PROTECTION LOUVRES

Efficient solution for solar ray incidence control in the building's interior temperature. Solar radiation is absorbed and reflected by these external louvres, facilitating energy efficiency and decreasing the need for artificial refrigeration. In addition, they serve as a decorative element bringing an avant-garde aesthetic to the façade.

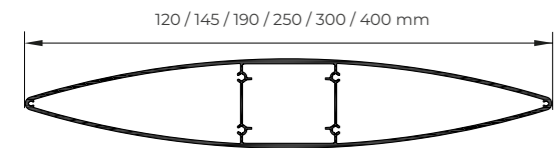

### Louvre type

Fixed: Regulation 0°, 15°, 30° or 45°.  
Adjustable: Motorized and manual.

Louvre size	Max recommended length to fixed louvres	Maximum recommended length to adjustable louvres
120 mm	1,8 metres	
145 mm	2,2 metres	1,9 metres
190 mm	2,5 metres	2,4 metres
250 mm	3,0 metres	3,0 metres
300 mm	3,5 metres	3,4 metres
400 mm	4,2 metres	4,0 metres

Depending on project specifications a larger free louvre length will be attainable (Consult)



### Profile Thickness

Louvres	Thickness
120 mm	1,25 mm
145 mm	1,35 mm
190 mm	1,70 mm
250 mm	1,90 mm
300 mm	2,00 mm
400 mm	2,50 mm



### Wind load resistance

Class 6 (max.)

Reference test

Louvres	Length
120 mm	1,8 metres
145 mm	2,0 metres
190 mm	2,5 metres
250 mm	3,0 metres
300 mm	3,5 metres
400 mm	4,2 metres

Test carried out according UNE 1932

Solar Protection



# LATTICES DECORATIVE LOUVRES

Extruded aluminium slats designed to configure a double skin in external enclosures that allow to sieve the light facilitating air circulation.

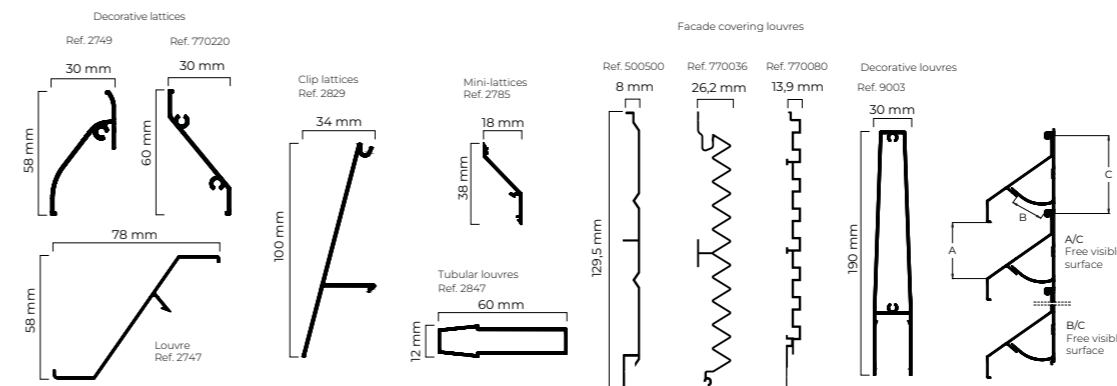

### Wind load resistance

**Lattice: UNE 13659 Class 6 (max.)**

test reference 2.0 metres

**Mini-lattice: UNE 13659 Class 5**

Test reference 1.3 metres

**Tubular louvres: UNE 13659 Class 6 (max.)**

Test reference 1.3 metres

Test carried out according to -UNE 1932

Louvre type	Max. recommended free length	A/C	B/C
Lattices (Ref. 2747)	2,0 metres	71%	44%
Decorative lattices (Ref. 2749)	1,5 metres	61%	34%
Clip lattices (Ref. 2829)	2,0 metres	100%	24%
Mini-lattices (Ref. 2785)	1,3 metres	55%	39%
Tubular louvres (Ref. 2847)	2,0 metres	76%	-
Decorative louvres (Ref. 9003)	6,5 metres	86%	-
Façade covering louvres (Ref. 500500)	-	-	-
Façade covering louvres (Ref. 770036)	-	-	-
Façade covering louvres (Ref. 770080)	-	-	-

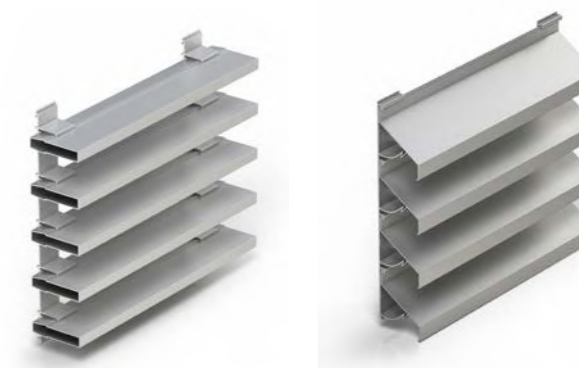

Solar Protection





SOLAR PROTECTION **LOUVRES**



LATTICES  
DECORATIVE LOUVRES



# TAMIZ

Side hung, sliding or bifold shutter system with fixed or adjustable louvres.

## FEATURES

Thermal resistance of the shutter and the thermal chamber   $\Delta R = 0,08 \text{ (m}^2\text{K/W)}$

Wind resistance  Class 5

Reference test 1,50 x 1,50 m / 2 sashes

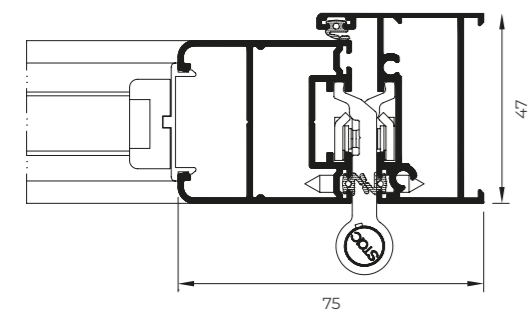

### Sightlines

Frame 47 mm

Sash 40 mm

### Profile Thickness

Window 1,3 mm

Door 1,5 mm

### Maximum Sash Weight

Side hung 65 kg

Bifold 50 kg

Sliding 120 kg

### Maximum Sash Dimensions

#### Side hung:

Width (L) 1600 mm, Height (H) 2500 mm

#### Bifold:

Width (L) 700 mm, Height (H) 2500 mm

#### Sliding:

Width (L) 2000 mm, Height (H) 3500 mm

## Transmittance

Uw window transmittance  
Uws transmittance of the window-shutter system

Uw(W/m <sup>2</sup> K)	Uws(W/m <sup>2</sup> K)
0,8	0,75
1,0	0,93
1,2	1,09
1,4	1,26
1,6	1,42
1,8	1,57
2,0	1,72
2,2	1,87
2,4	2,01
2,6	2,15
2,8	2,29
3,0	2,42
3,2	2,55



## Closing possibilities

Closing with fixed or adjustable louvres

Opaque closing (sandwich panel)

Glazed closing

## OPENING POSSIBILITIES

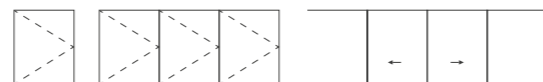

Side hung  
Sliding  
Bifold

Solar  
Protection



# MALLORQUINA

Side hung shutter system with fixed or adjustable louvres

## FEATURES

Thermal resistance of the shutter and the thermal chamber   $\Delta R = 0,08 \text{ (m}^2\text{K/W)}$

Wind resistance  Class 5

Reference test 1,50 x 1,50 m / 2 sashes

Uw(W/m <sup>2</sup> K)	Uws(W/m <sup>2</sup> K)
0,8	0,75
1,0	0,93
1,2	1,09
1,4	1,26
1,6	1,42
1,8	1,57
2,0	1,72
2,2	1,87
2,4	2,01
2,6	2,15
2,8	2,29
3,0	2,42
3,2	2,55

Uw window transmittance  
Uws transmittance of the window-shutter system

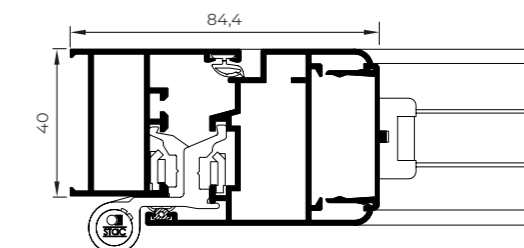

## OPENING POSSIBILITIES



Side hung of 1, 2, 3 and 4 sashes

### Sightlines

Frame 40 mm

Sash 48 mm

### Profile Thickness

Window 1,3 mm

Door 1,4 mm

### Maximum Sash Weight

75 Kg

### Maximum Sash Dimensions

Width (L) 1500 mm

Height (H) 2400 mm



Solar  
Protection





TAMIZ SYSTEM

contemporary  
enclosures



**balustrading** systems

# BALUSTRADE

## View Crystal / View Crystal Plus

Enjoy excellent views without any visual obstacle thanks to this balustrade system based on a "U" shaped aluminium profile on which laminated safety glass is fixed. Possibility of led strip illumination and drainage solution for exposed areas. Option of aluminium embellishing profile on the upper edge.

**VIEW CRYSTAL:** Resists a load of 1,0 kN/m applied at 1,1 metres from its bottom part. Suitable for use in areas A1, A2, B, C1, C2, D1, D2, G1 and G2, included in the CTE DB SE-AE, and A, B, C1, C2, C3, C4, D and E, in accordance with Eurocode 1.

**VIEW CRYSTAL PLUS:** Resists a load of 3,0 kN/m. Suitable for use in all areas from CTE DB SE-AE and areas A, B, C1, C2, C3, C4, C5, D and E, in accordance with Eurocode 1.

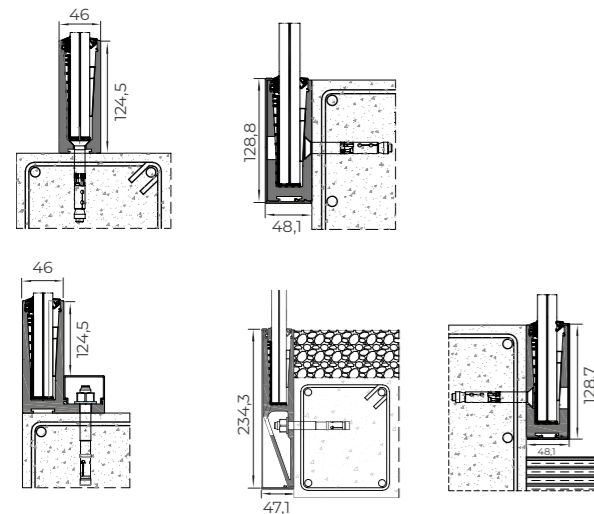

### Assembly Possibilities

- Over slab
- Flush over slab
- Edge slab
- Inverted edge slab
- Flush with the slab
- Flush with the pavement

### Maximum Height

1100 mm

Tests according to standards UNE 85237, UNE 85238 and UNE 85240. Established requirements in CTE (DB SU-1 and DB SE-AE) And established requirements in Eurocode 1 according to EN 1991-1-1/AC

Static horizontal test towards the exterior

Static horizontal test towards the interior

Dynamic test with mild object

Dynamic test with hard object

Verification of section 3.2 of DB-SE-AE of CTE

Verification of the specifications of the Eurocode 1 according to table 6.12 for use categories of 3kN/m

### Classification according to UNE 85240, Class A-Excellent

Reference test on balustrade with glass and extruded aluminium, fixed to the slab edge with 1100 (H) X 1500 mm (L) of total dimensions above ground level

Reference test on balustrade with glass and extruded aluminium, fixed over the slab with 1100 (H) X 1500 mm (L) of total dimensions above ground level.

### LAMINATED GLASS COMPOSITIONS

10-1,52-10	10-1,14-10	10-0,76-10	10-0,38-10
8-1,52-8	8-1,14-8	8-0,76-8	8-0,38-8
6-1,52-6	6-1,14-6	6-0,76-6	6-0,38-6

Balustrades



## VIEW CRYSTAL BALUSTRADE



# BALUSTRADE

## Classic

Traditional balustrade system with bar or glass aspect.  
Possibility of fixing to slab or to the edge of the slab.

Balustrades

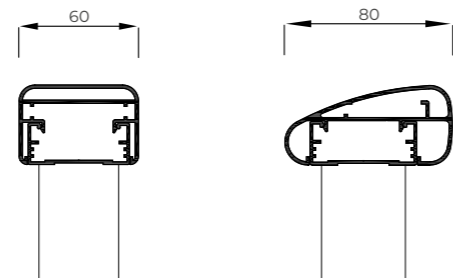

### Possibilities

- Glass balustrading
- Glass balustrading with free top edge
- Bar balustrading
- Bar balustrading with free top edge

### Handrail Possibilities

- Square - 60 mm width
- Circular - 66 mm diameter
- Elliptical - 80 mm external perimeter

### Maximum Dimensions Between Pilasters

1000 mm

### Minimum Height

900 mm

### Classification according to UNE 85240, Class A-Excellent

Reference test on glass balustrading at a total height of 1100 (H) x 2450 mm (L) and 3 pilasters.  
Reference test on bar balustrading with top free edge of 1100 (H) x 2000 mm (L) and 3 pilasters.

Tests according to standards UNE 85237, UNE 85238 and UNE 85210.

Requirements established in CTE (DB SU-1 and DB SE-AE)

Static horizontal test towards the exterior  
Static horizontal test towards the interior  
Static vertical test  
Dynamic test with mild object  
Dynamic test with hard object  
Verification of section 3.2 of DB-SE-AE of CTE  
Security test

## CLASSIC BALUSTRADE



# JULIET

## Balcony

Balustrading solution for installation on the exterior of the carpentry by means of concealed fixings, allowing for the total opening of balconies without the risk of falling.

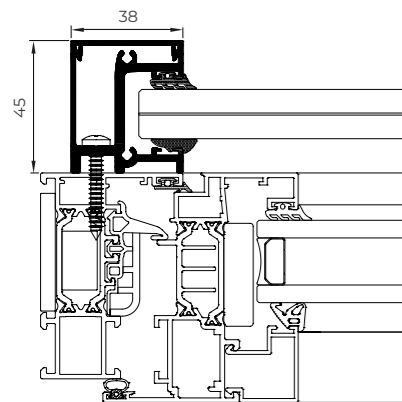

**Classification according to UNE 85240, Class A-Excellent**  
Reference test on glass and extruded aluminium balustrade of 1200 (H) x 1800 mm (L).

Tests according to standards UNE 85237, UNE 85238 and UNE 85240.  
Requirements established in CTE (DB SU-1 AND DB SE-AE) and in Eurocode 1 according to EN 1991-1-1 for use category of up to 1,6 kN/m.

Static horizontal test towards the exterior.  
Static horizontal test towards the interior.  
Static vertical test.  
Dynamic test with mild object.  
Dynamic test with hard object.  
Verification of section 3.2 of DB SE-AE of CTE.  
Security test.

LAMINATED GLASS COMPOSITIONS	
8-1,52-8	6-1,52-6
8-1,14-8	6-1,14-6
8-0,76-8	6-0,76-6
8-0,38-8	6-0,38-6



**Maximum width**  
1800 mm

Balustrades



JULIET  
BALCONY

contemporary  
enclosures



**accessories**

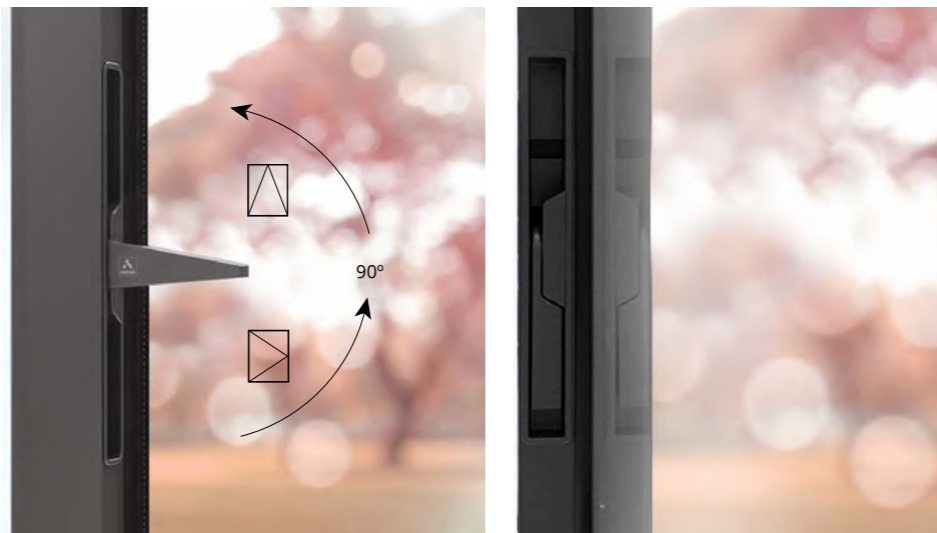
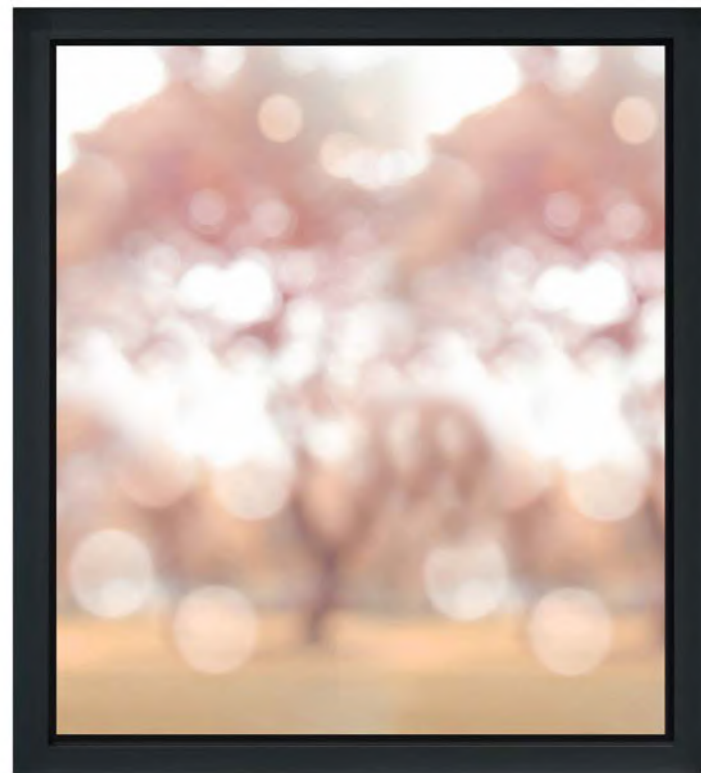

## ARCH INVISIBLE HANDLE

Exclusive handle integrated within the sash, imperceptible from the frontal view

Compatible with the COR 80 Hidden Sash and COR 70 Hidden Sash systems  
Ergonomics, robustness and easy handling in the opening and closing operations  
Ideal for combination with concealed hinges, achieving a totally clean aesthetic  
Dimensions 27.5 x 234 mm



## MINIMALIST HANDLE

Avant-garde design without escutcheon  
Suitable for all Euro-Groove hinged series  
and PVC series  
Specific transmission box  
Possibility of painting in the same colour  
as the carpentry  
Spindle: 8 mm  
Dimensions: 32 x 148 mm





### **CORTIZO HANDLE**

Reduced escutcheon design  
Adaptability to transmission box and multilock system  
Concealed hardware  
Spindle: 7 mm  
Dimensions 32 x 148 mm



### **CORTIZO DOOR HANDLE**

Reduced escutcheon design  
Opening to the right and to the left versions  
Suitable for exterior and interior assembly  
Available in door version  
Concealed hardware  
Spindle: 8 mm  
Dimensions 32 x 148 mm



### **INOX HANDLE**

Reduced escutcheon design  
Adaptability to transmission box and multilock system  
Available in door version  
Concealed hardware  
Spindle: 7 mm  
Dimensions: 31 x 135 mm



**SIRIUS  
HANDLE**

Curved aesthetics  
Design with a reduced escutcheon  
Suitable for multipoint lock  
Available for windows or doors  
Spindle: 7 mm  
Dimensions: 32 x 155 mm



**CORTIZO CREMONE  
WITH KEY**

Maximum security  
3 locking positions: full lock, tilt only and tilt and turn  
Dimensions: 33 x 190 mm



**REMOVABLE  
CORTIZO CREMONE**

Easy assembly  
Handle clipped on the escutcheon  
Possibility of removing the handle in any position  
Maximum durability  
Dimensions: 33 x 173 mm



**ART INFINITY  
PULL HANDLE**

Suitable for high traffic and large dimension doors  
Straight or curved design  
Dimensions: 450 x 50 mm



**LIFT & SLIDE  
HANDLE**

Avant-garde aesthetic  
Exclusive to systems 4600 and 4500 Lift & Slide  
Versions with or without key  
Multiple combinations: handle / handle handle / finger pull  
Tested to 25,000 cycles  
Spindle of 10 mm  
Dimensions: 37 x 290 mm



**CORTIZO OFFSET  
HANDLE**

Handle specially designed for sliding systems  
Reduced escutcheon  
Suitable for exterior and interior  
Spindle: 7 mm  
Dimensions: 32 x 158 mm



**VISION SECURITY  
LOCK**

Key lockable  
Integration of the locking system in the profile with minimalist aesthetics  
Up to 4 locking points  
Dimensions: 36 x 260 mm



**FLUSH VISION  
SECURITY LOCK**

Key lockable  
Lock flush with the profile  
Up to 4 locking points  
Dimensions: 36 x 260 mm



**VISION SECURITY  
MINI LOCK**

Straight aesthetics in line with the minimalist style of the system  
Dimensions: 26 x 92 mm



**VISION  
CENTRAL LOCK**

Suitable for the COR VISION and COR VISION PLUS systems  
Integrated in the interlock profile  
It allows to conceal the lateral sashes  
Dimensions: 450 x 50 mm



### CORTIZO HD HARDWARE

Hinge specially designed for large dimensions  
such as floor to ceiling solutions

3D regulation

Maximum dimensions: 1200 x 3500 mm\*

Maximum weight/sash: 160 Kg

\* For window configurations of large dimensions and weight,  
consult with the Cortizo Architecture and Engineering Department.



## SPECIAL HARDWARES



### EVO SOFT HARDWARE

3D regulation. All locking points are adjustable  
Closing force up to 50% less than  
traditional hardware

Possibility of multiple locking points

All sliding elements incorporate a clip to  
eliminate unnecessary gaps

Maximum weight/sash: 120 Kg

For window configurations of large dimensions  
and weight, consult with the Cortizo  
Architecture and Engineering Department

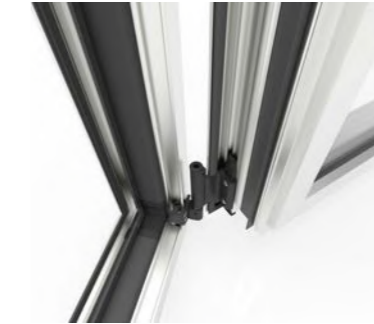

### EVO SOFT CLX 160 KG HARDWARE

3D regulation. All locking points are adjustable  
Closing force up to 50% less than traditional  
hardware

Possibility of multiple locking points

All sliding elements incorporate a clip to eliminate  
unnecessary gaps

Maximum weight/sash: 160 Kg

For window configurations of large dimensions  
and weight, consult with the Cortizo  
Architecture and Engineering Department



### EVO SECURITY HARDWARE

High security hardware  
Mushroom security cams with tightness  
adjustment and anti-theft locks  
protection against breakage and robbery  
Possibility of up to 14 locking points



